



**VERTICAL SCHOOLS TURNING CHALLENGES INTO OPPORTUNITIES**





**ELAINE E. THOMPSON ELEMENTARY SCHOOL**  
LOUDOUN COUNTY, VA  
3 STORIES



**FREDERICK COUNTY MIDDLE SCHOOL**  
FREDERICK COUNTY, VA  
4 STORIES



**CENTREVILLE HIGH SCHOOL**  
FAIRFAX COUNTY, VA  
4 STORIES



**MERIDIAN HIGH SCHOOL**  
FALLS CHURCH, VA  
7 STORIES



**HIGH SCHOOL 14**  
LOUDOUN COUNTY, VA  
4 STORIES

**WATSON MOUNTAIN MIDDLE SCHOOL**  
LOUDOUN COUNTY, VA  
4 STORIES



Alexandria  
Arlington  
Falls Church

**ARLINGTON CAREER CENTER**  
ARLINGTON COUNTY, VA  
4 STORIES

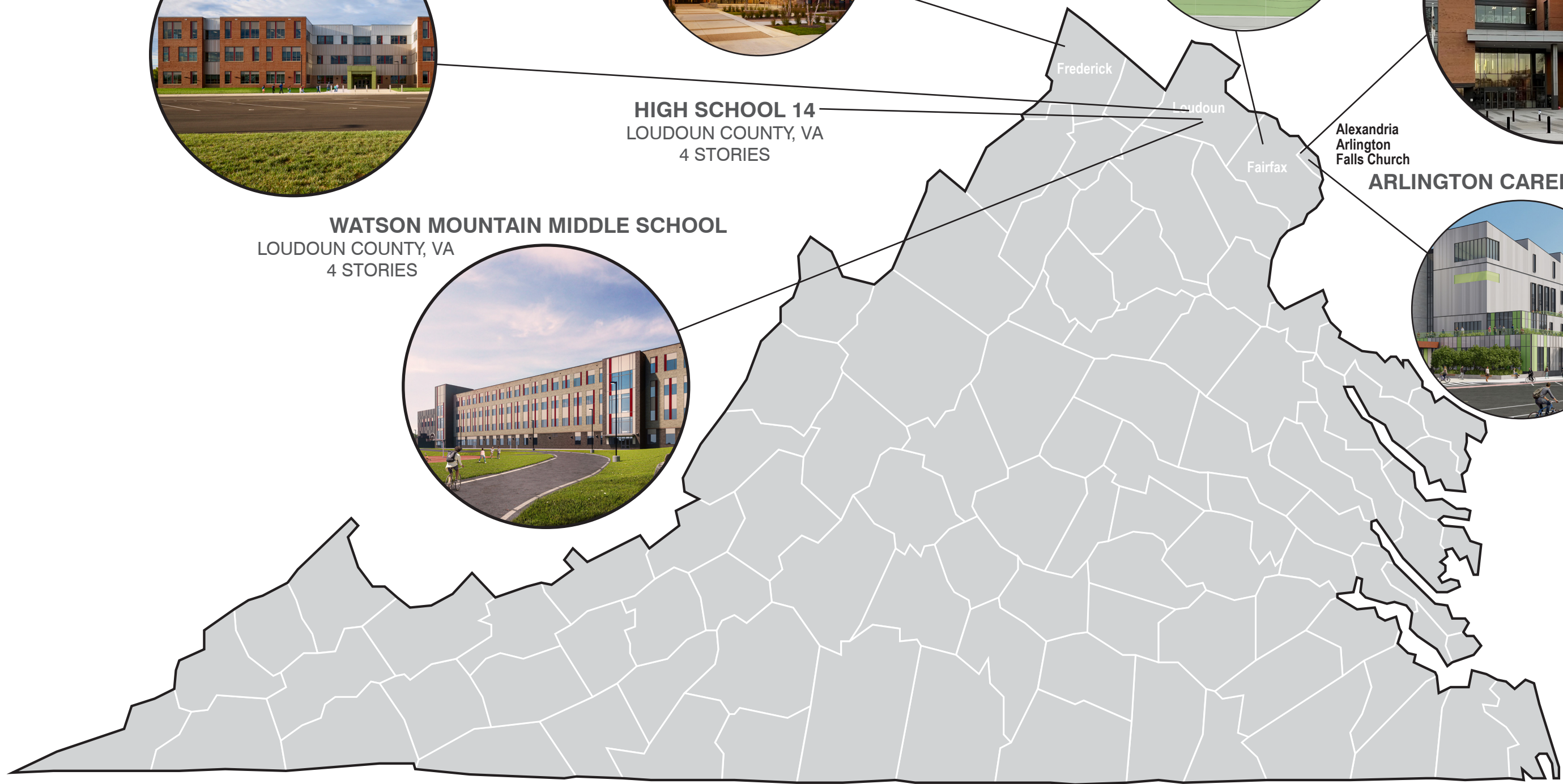

REGIONAL VERTICAL SCHOOLS





FCCPS MERIDIAN HIGH SCHOOL

VERTICAL SCHOOLS TURNING CHALLENGES INTO OPPORTUNITIES





ORIG. SITE: 24 ACRES

CAPACITY: 1,200

295,000 GSF

STADIUM

MULTI-PURPOSE FIELD

BASEBALL FIELD

SOFTBALL FIELD

4 TENNIS COURTS

200 PARKG. SPACES

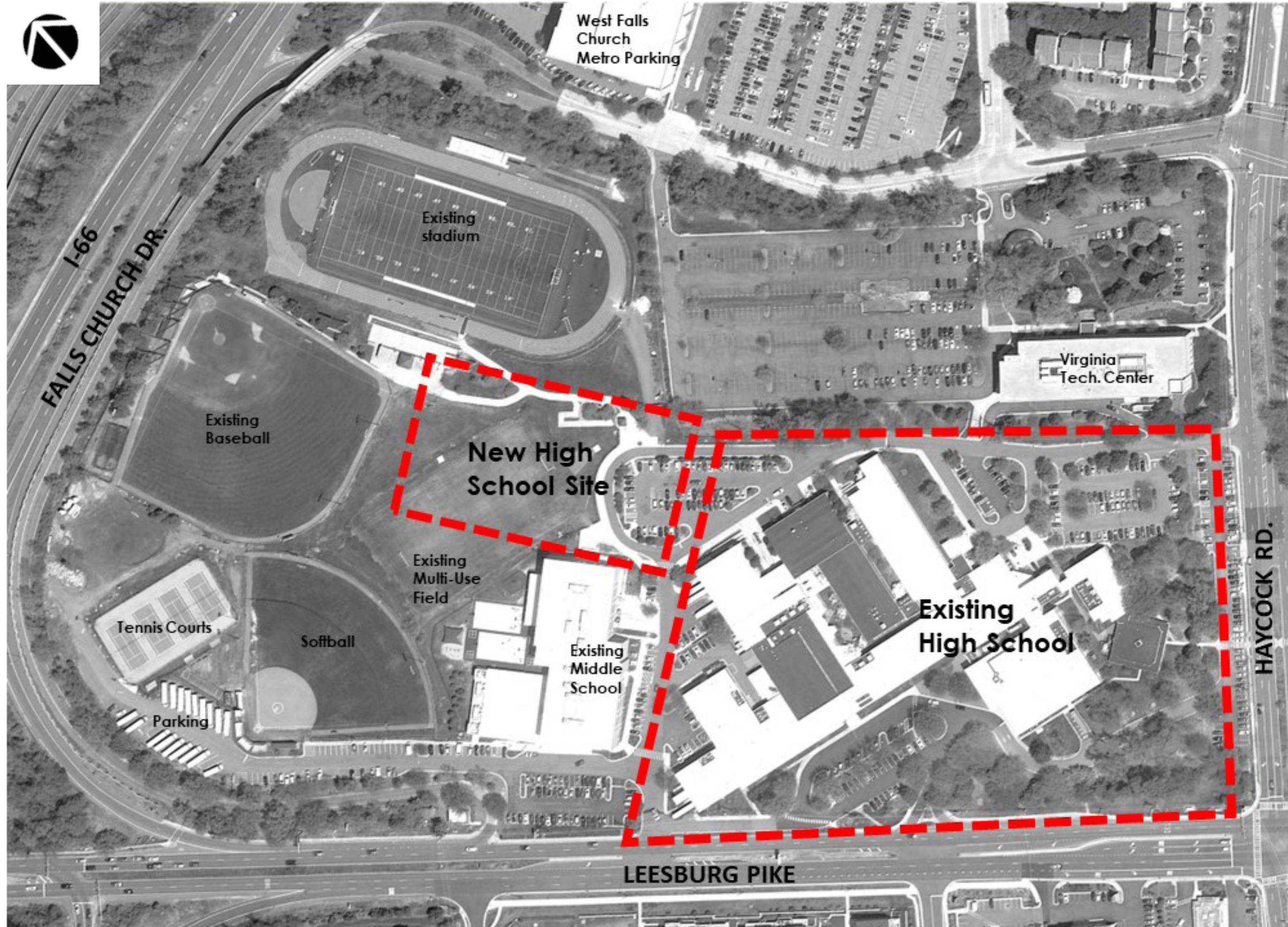

FCCPS MERIDIAN HIGH SCHOOL



NEW SITE: 14 ACRES

CAPACITY: 1,200

295,000 GSF

STADIUM

MULTI-PURPOSE FIELD

BASEBALL FIELD

SOFTBALL FIELD

6 TENNIS COURTS

200 PARKG. SPACES

NET ZERO READY

GEO THERMAL

7 STORIES



FCCPS MERIDIAN HIGH SCHOOL



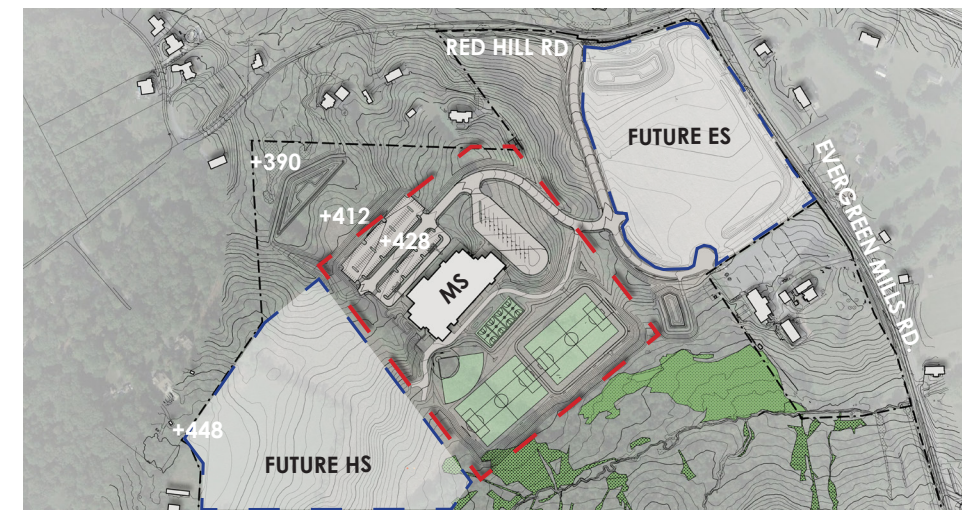

LCPS WATSON MOUNTAIN MIDDLE SCHOOL



ED SPEC SITE: 35 ACRES

SITE: 33 ACRES

CAPACITY: 1,455

210,000 GSF

STADIUM

SOFTBALL FIELD

2 MULTI-PURPOSE FIELDS

4 BASKETBALL COURTS

240 PARKG. SPACES

22 BUSES

4 STORIES

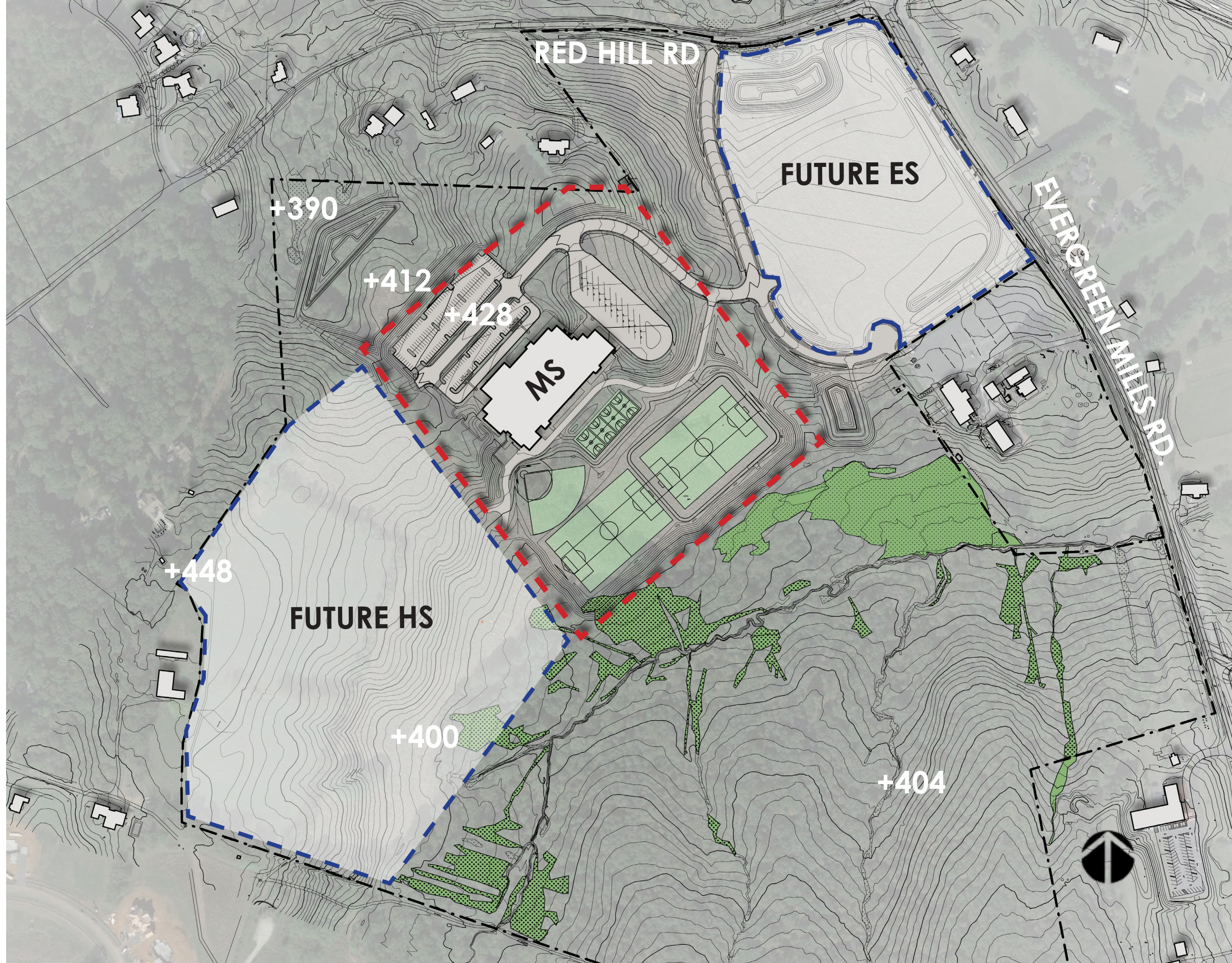

LCPS WATSON MOUNTAIN MIDDLE SCHOOL



ED SPEC SITE: 35 ACRES  
SITE: 33 ACRES  
CAPACITY: 1,455  
210,000 GSF  
STADIUM  
SOFTBALL FIELD  
2 MULTI-PURPOSE FIELDS  
4 BASKETBALL COURTS  
240 PARKG. SPACES  
22 BUSES  
4 STORIES

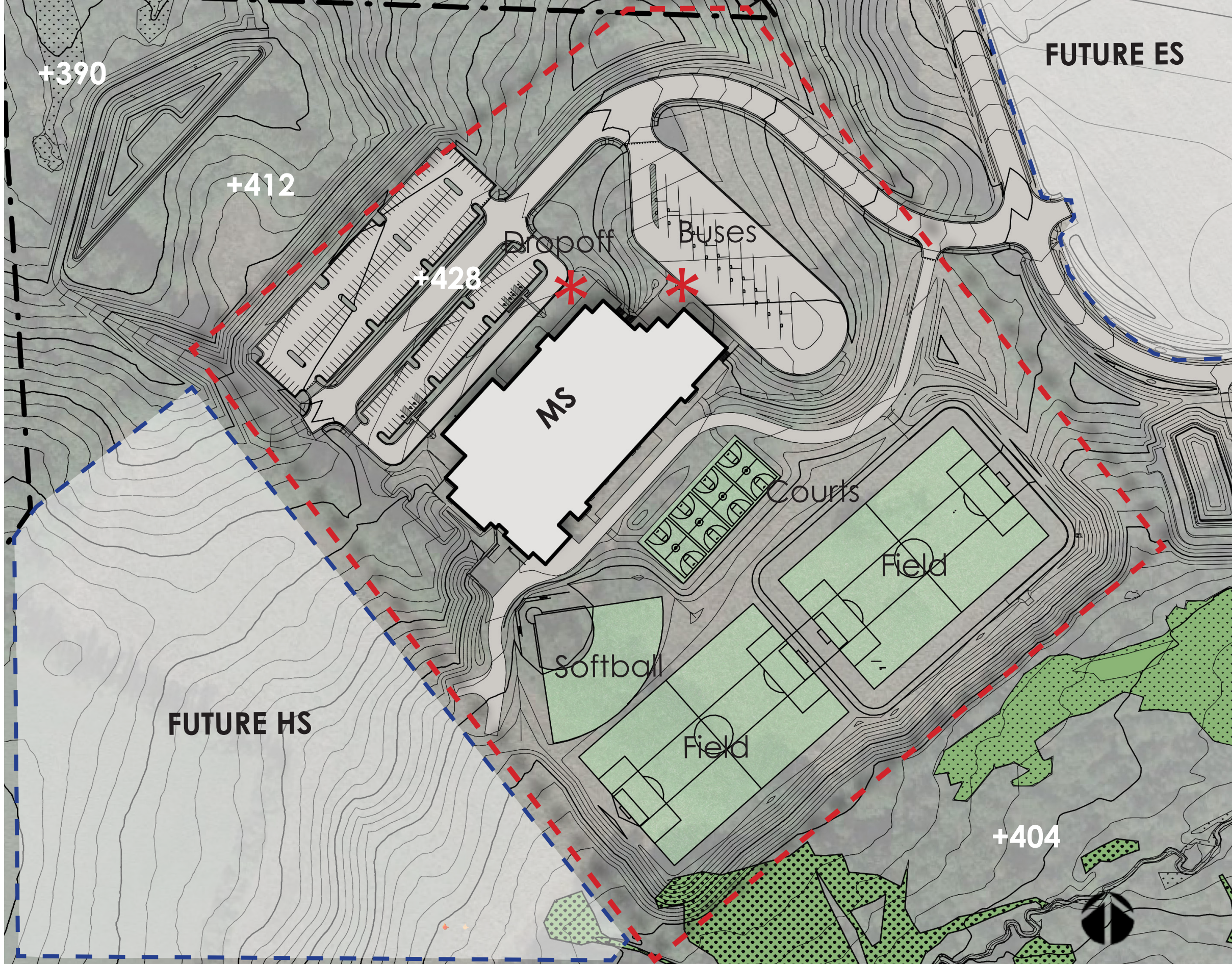

LCPS WATSON MOUNTAIN MIDDLE SCHOOL



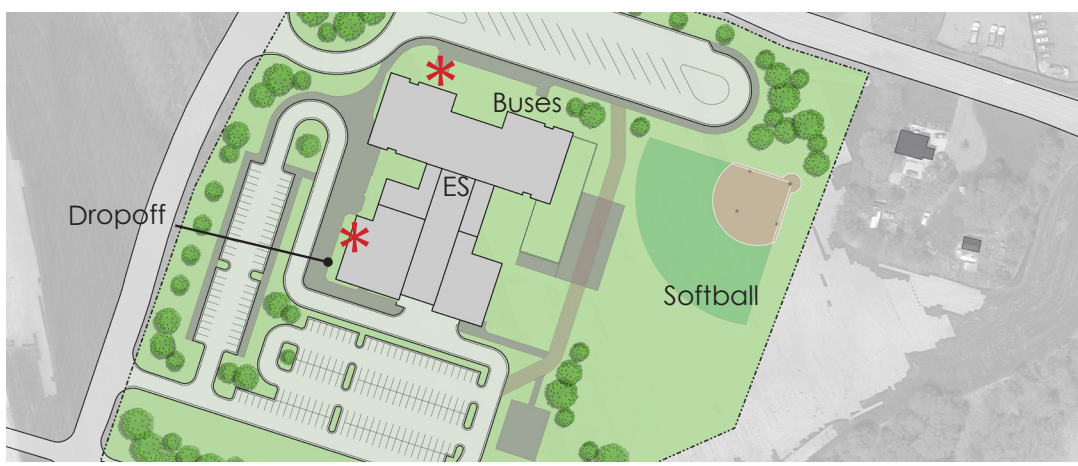

LCPS ELAINE E. THOMPSON ELEMENTARY SCHOOL



ED SPEC SITE: 20 ACRES

SITE: 13 ACRES

CAPACITY: 960

113,500 GSF

SOFTBALL FIELD

MULTI-PURPOSE FIELD

143 PARKG. SPACES

15 BUSES

3 STORIES



LCPS ELAINE E. THOMPSON ELEMENTARY SCHOOL



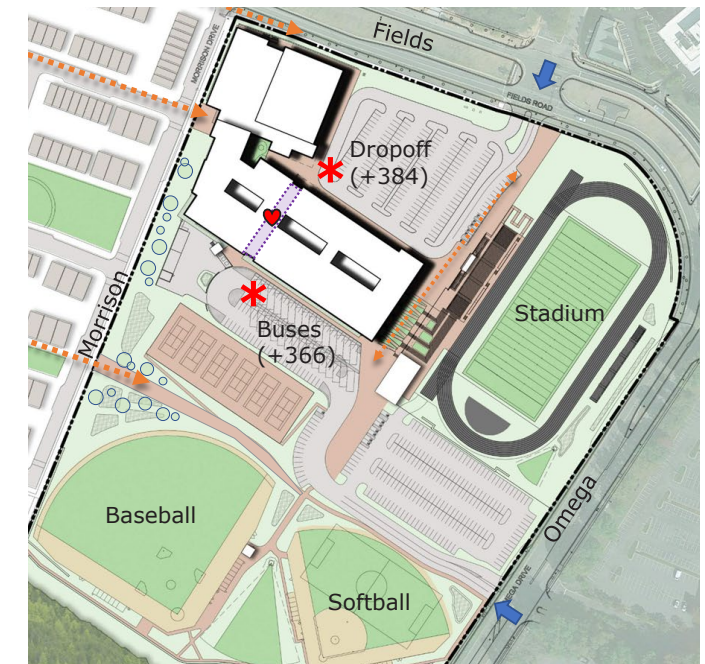

MCPS CROWN HIGH SCHOOL



ED SPEC SITE: 34 ACRES

SITE: 23 ACRES

CAPACITY: 1,700

350,000 GSF

STADIUM

MULTI-PURPOSE FIELD

BASEBALL FIELD

SOFTBALL FIELD

6 TENNIS COURTS

400 PARKG. SPACES

30 BUSES

GEO THERMAL

4 STORIES

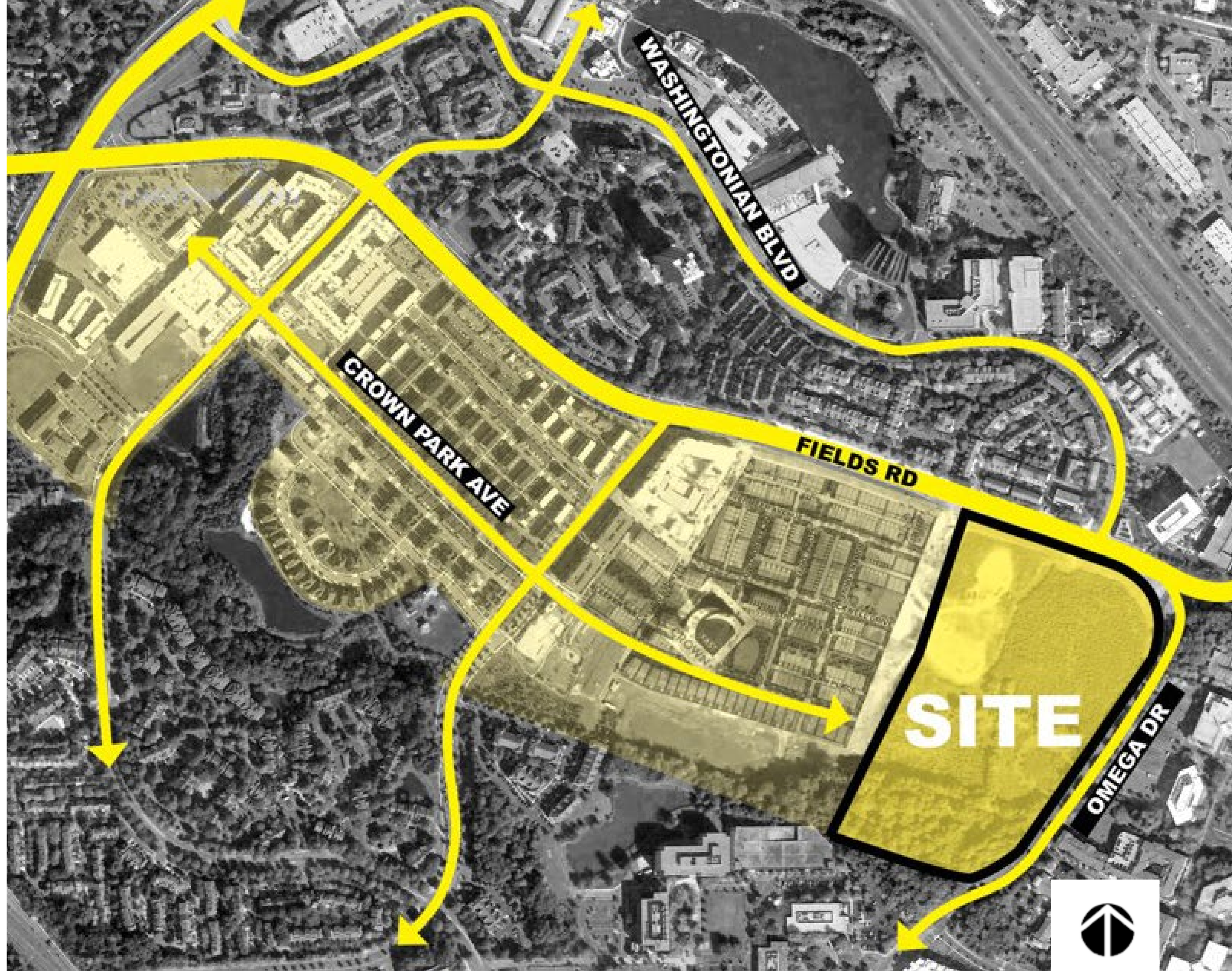

  
MCPS CROWN HIGH SCHOOL



ED SPEC SITE: 34 ACRES

SITE: 23 ACRES

CAPACITY: 1,700

350,000 GSF +/-

STADIUM

MULTI PURPOSE FIELD

BASEBALL FIELD

SOFTBALL FIELD

6 TENNIS COURTS

400 PARKG. SPACES

30 BUSES

GEO THERMAL

4 STORIES



MCPS CROWN HIGH SCHOOL





OPEN-MINDED

THINKERS

COMMUNICATORS

PRINCIPLED

BALANCED

KNOWLEDGEABLE

CARING



Our collective mission is to support our students as they move steadily toward being caring, balanced, and open-minded thinkers who continually inquire about the individual and collective roles they play in our global community. We foster an environment where our students are actively learning to serve themselves and others as principled risk-takers, with the responsibility to communicate a bond throughout cultures and generations. Our students work to become knowledgeable and reflective citizens connected to the ever-changing world around them.

CARING, BALANCED, AND OPEN-MINDED THINKERS

# STACKED ACADEMICS

VERTICAL SCHOOLS TURNING CHALLENGES INTO OPPORTUNITIES

ING GLOBAL



**PYP** PROGRAMME (PYP) AGES 3-5  
The PYP fosters curiosity and encourages children to take ownership of their learning. Developing skills necessary to become reflective, caring, and independent thinkers, PYP students take ownership of their learning and become active learners.

**MYP** PROGRAMME (MYP) AGES 6-12  
The MYP is a holistic framework that empowers students to take an active role in their learning and to be critical thinkers, creative, reasonably minded, and reflective.

**DIPLOMA PROGRAMME (DP)** AGES 16-19  
Students engaging in IB DP courses and completing the rigorous assessments are developing the skills and mindset to be able to pursue their dreams beyond high school and have a profound impact on their communities and the world.

**CAREER RELATED PROGRAMME (CRP)** AGES 16-19  
The CRP allows students to engage in career-related learning while developing the critical thinking skills and the practical approaches to learning needed to be successful in a global society.



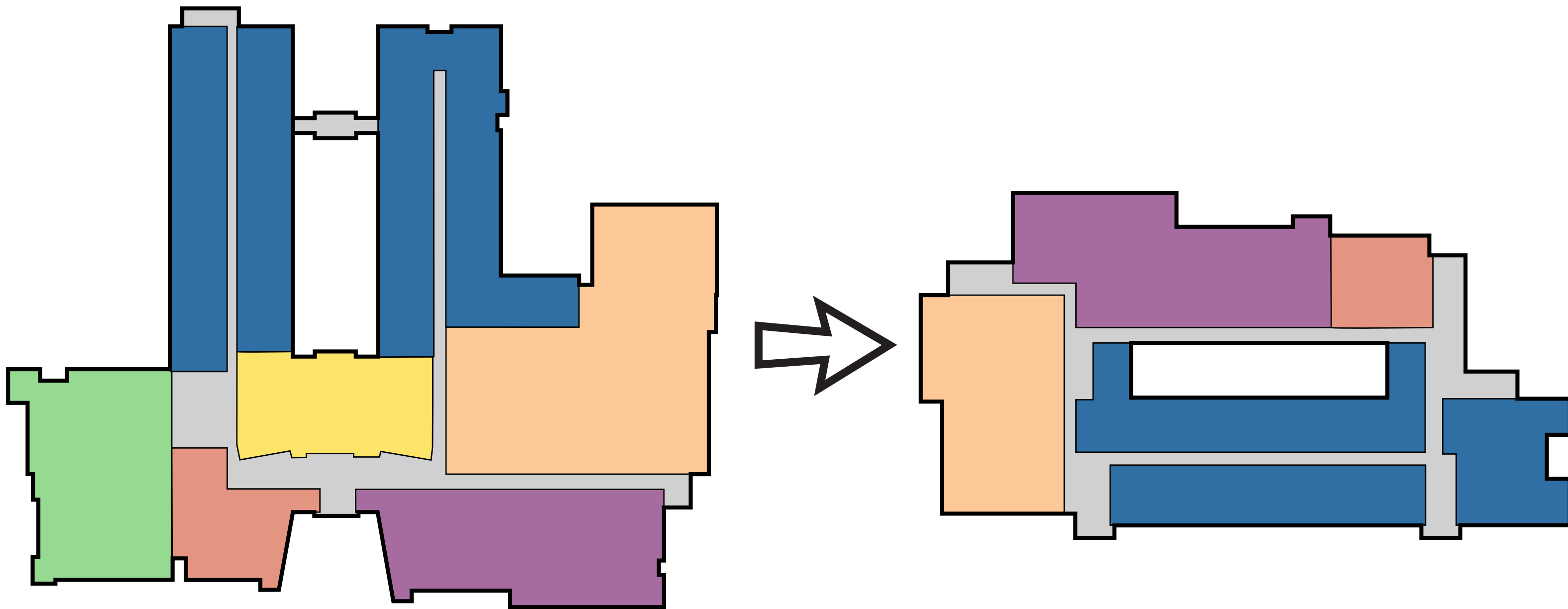

LCPS WATSON MOUNTAIN MIDDLE SCHOOL



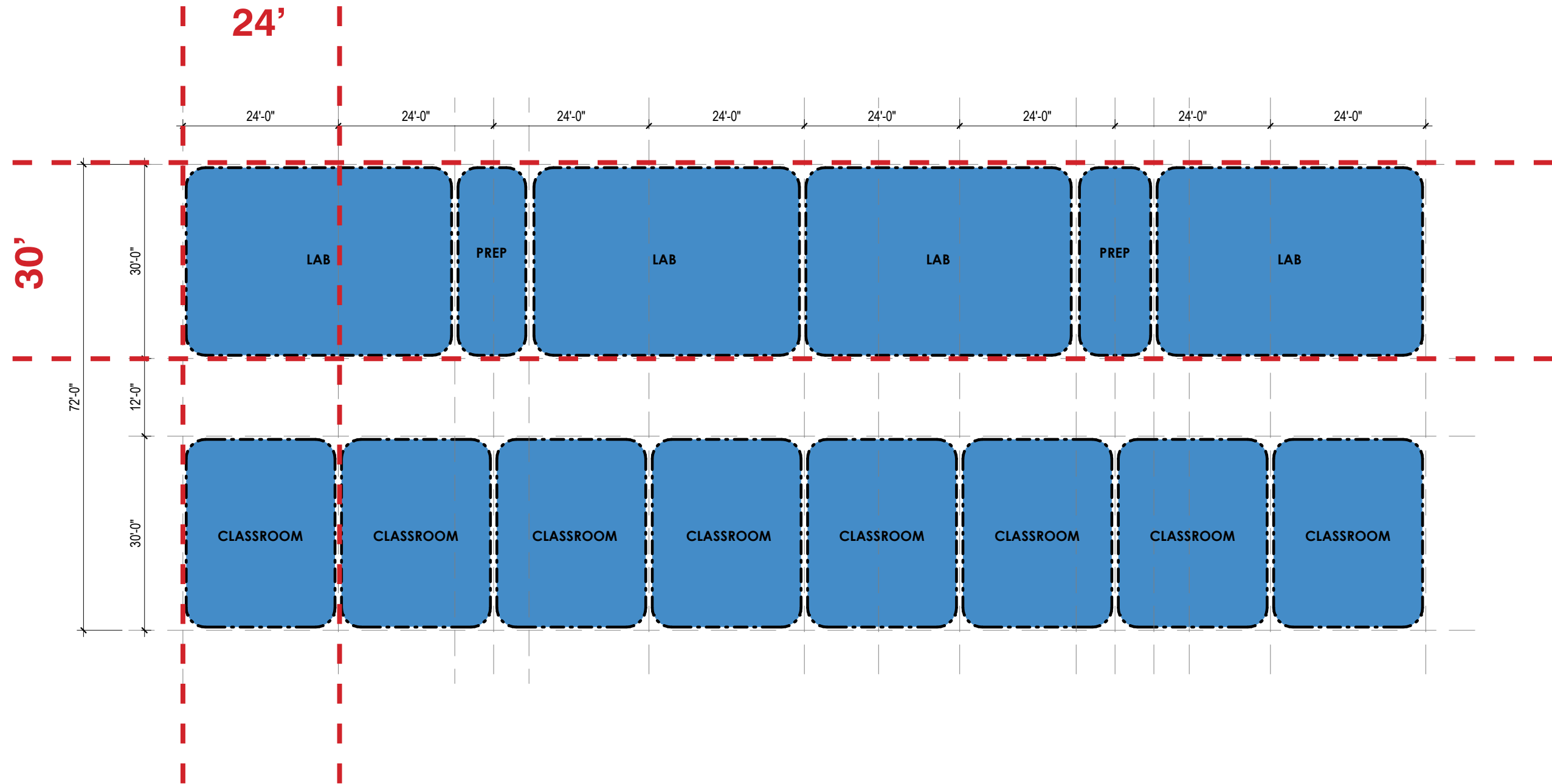

STACKED ACADEMICS MODULE



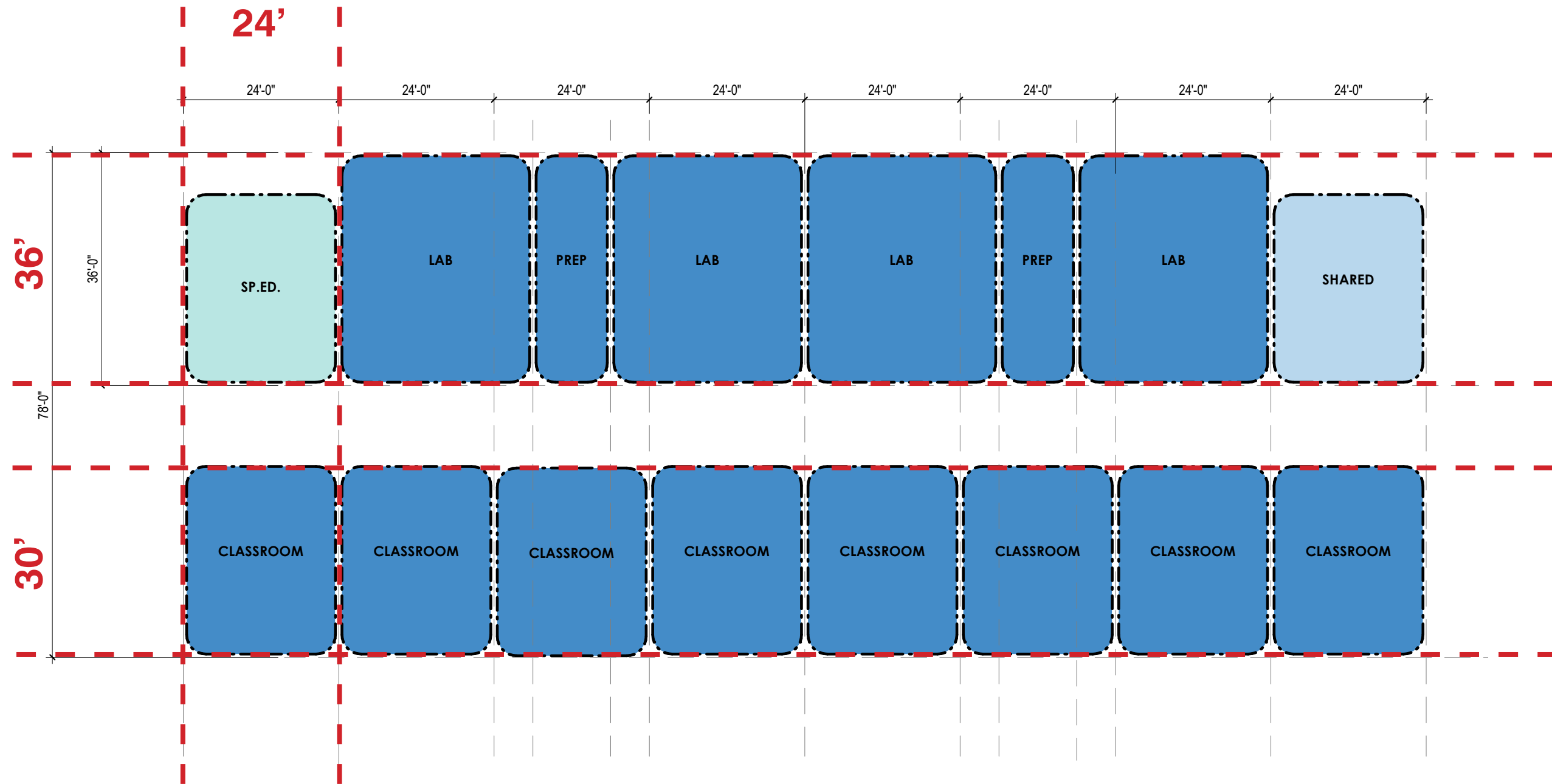

STACKED ACADEMICS MODULE



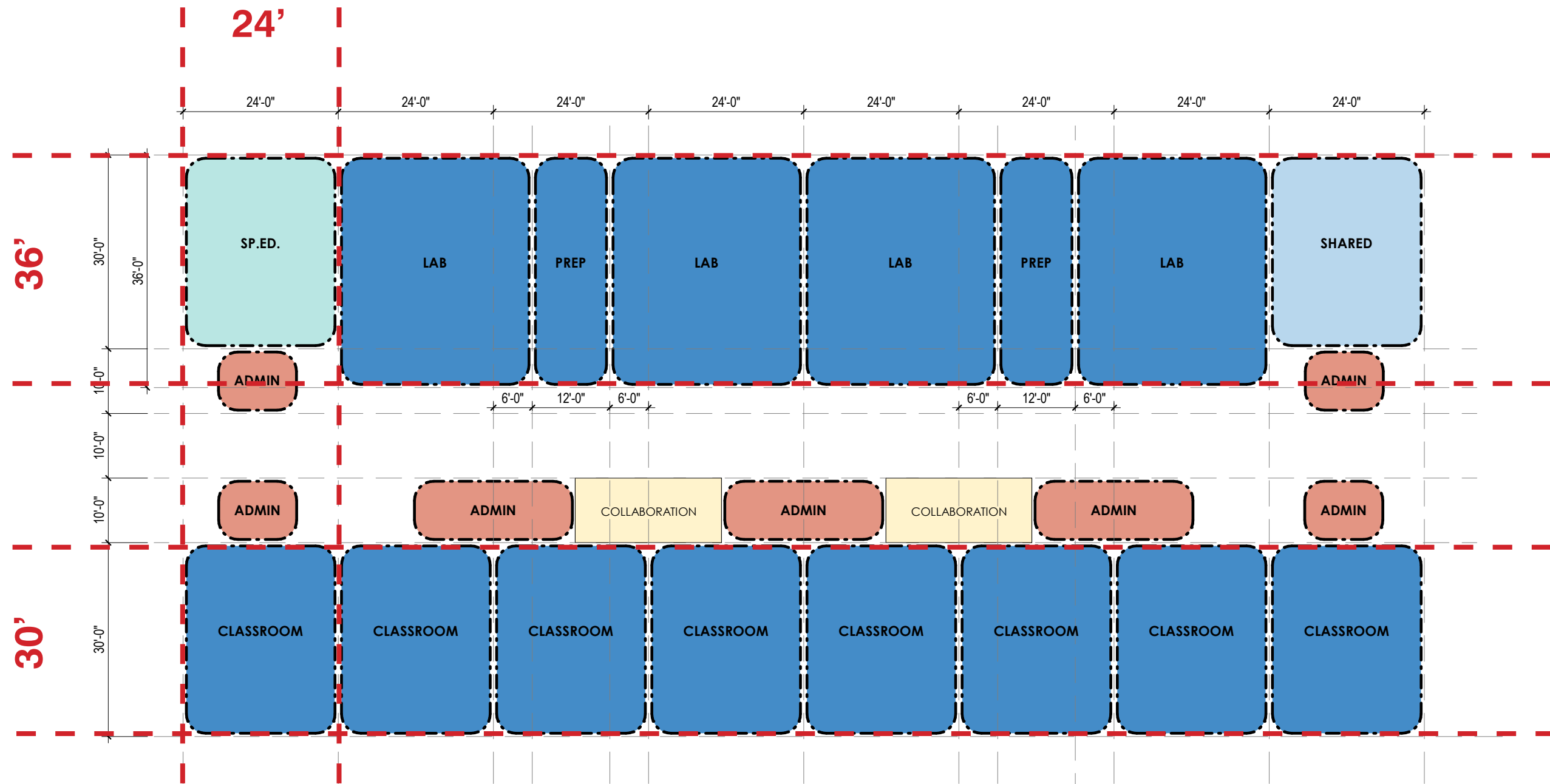

STACKED ACADEMICS MODULE



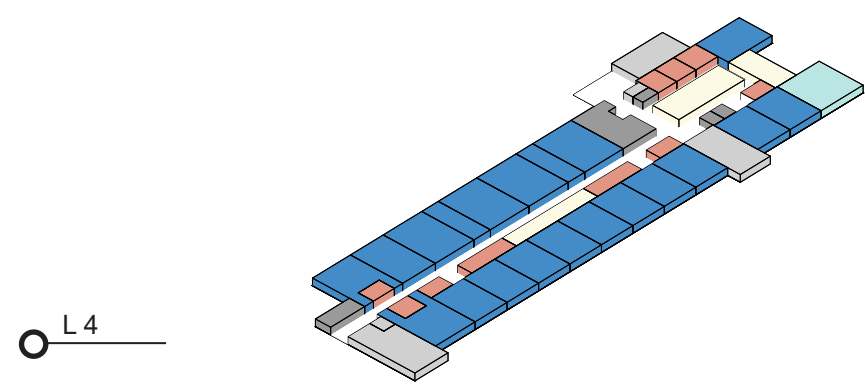

L 4

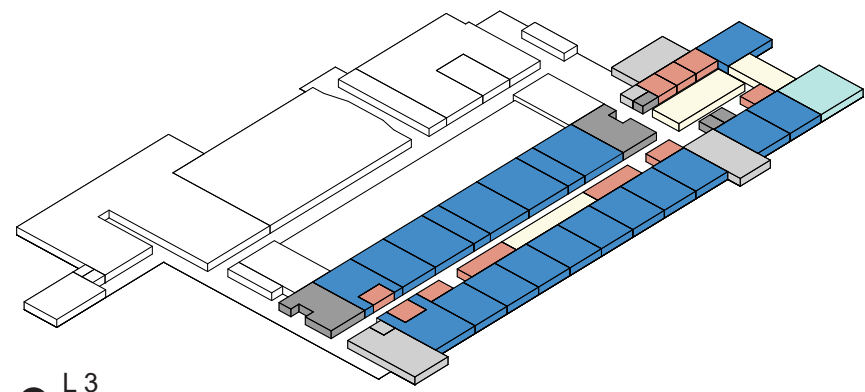

L 3

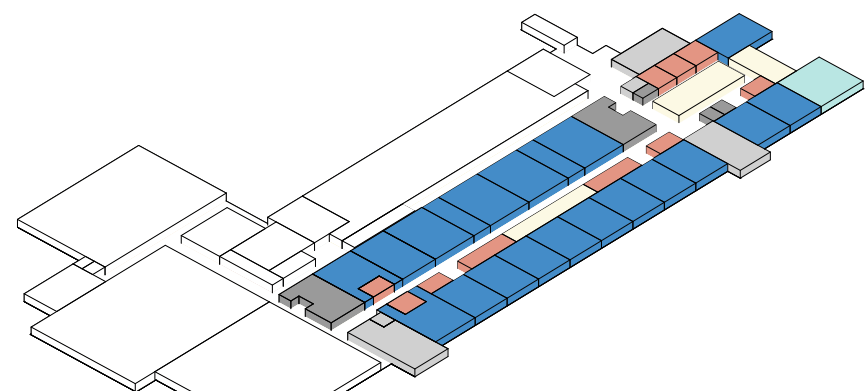

L 2

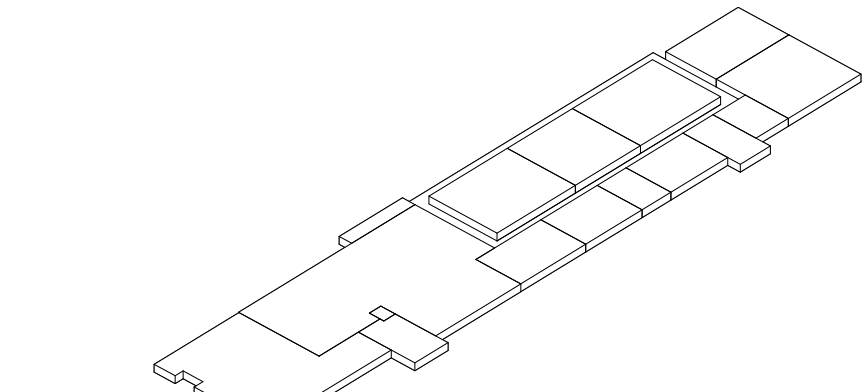

L 1

**STACKED ACADEMICS MODULE**

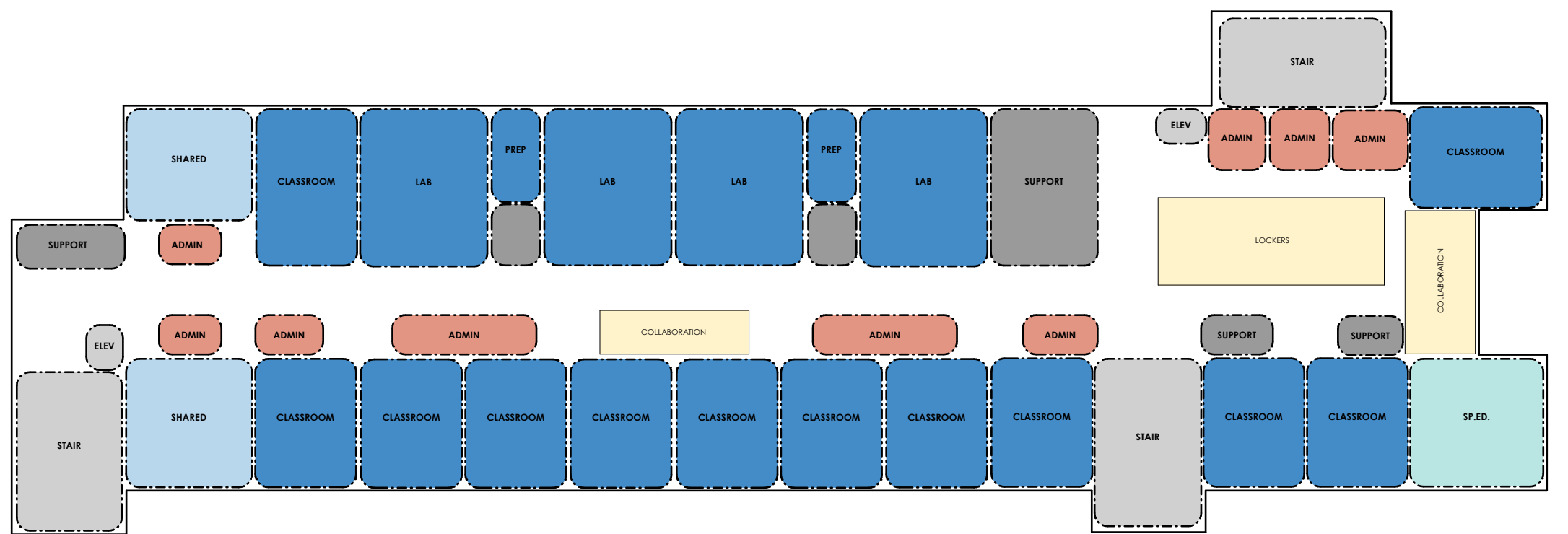

**LCPS WATSON MOUNTAIN MIDDLE SCHOOL**





L4

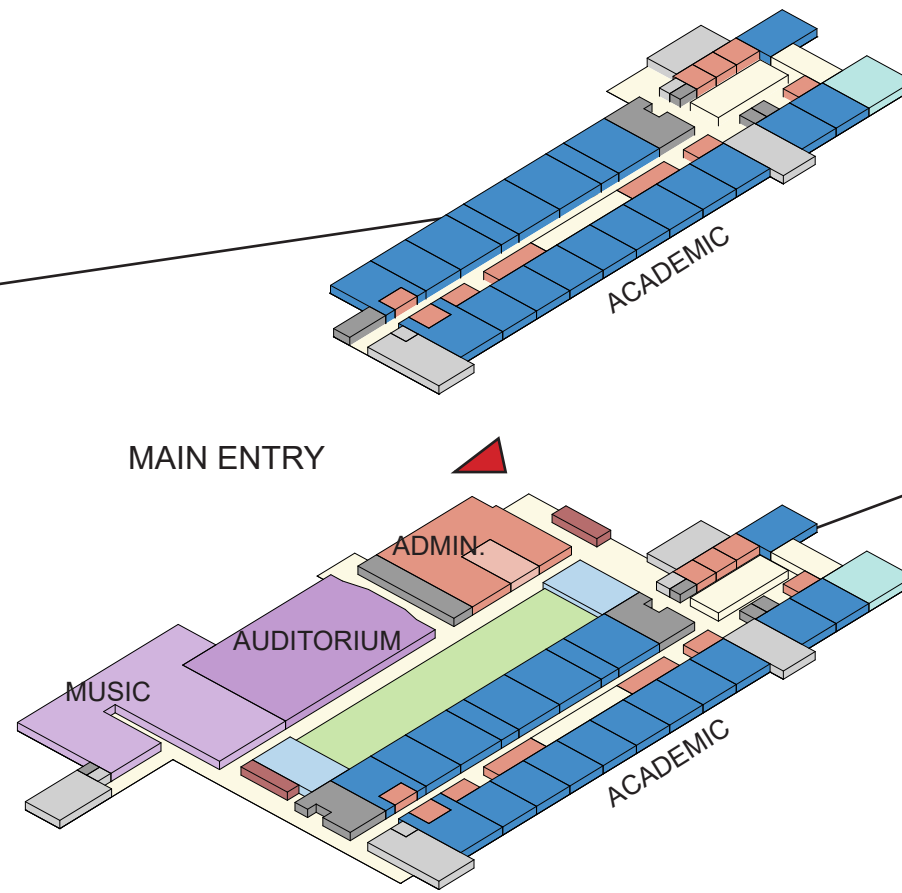

L3



L2

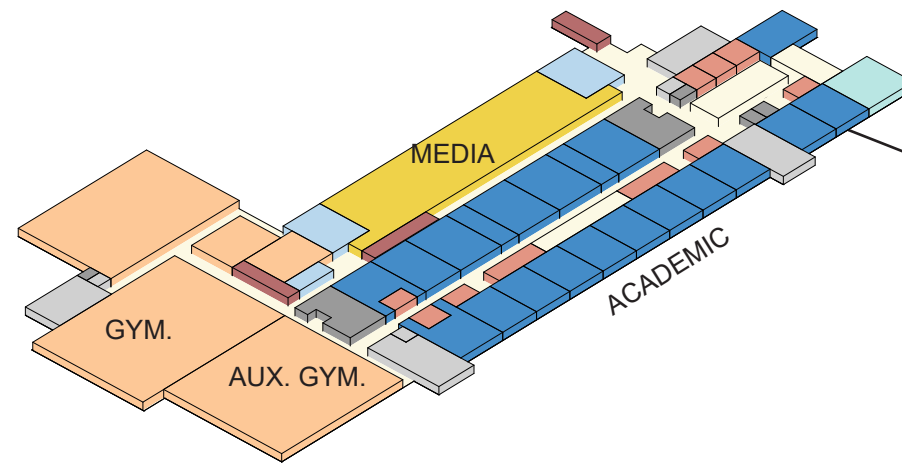

L1

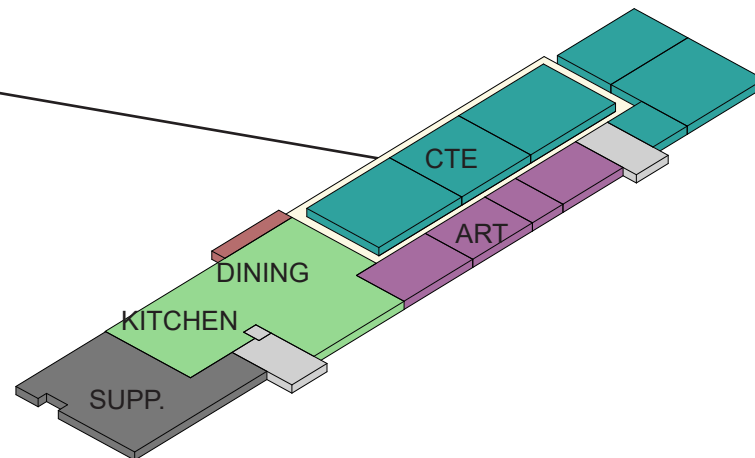

LCPS WATSON MOUNTAIN MIDDLE SCHOOL



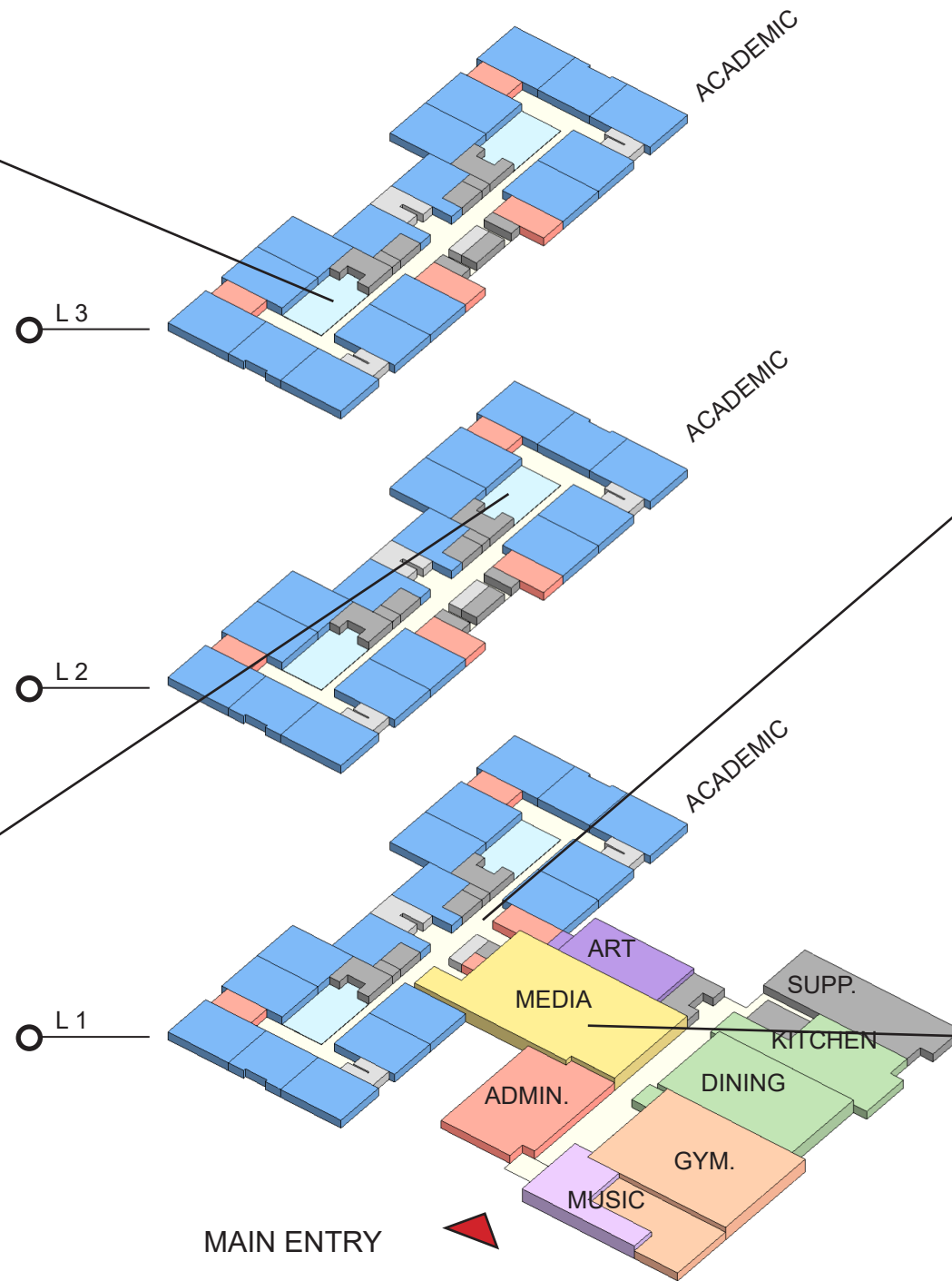

LCPS ELAINE E. THOMPSON ELEMENTARY SCHOOL



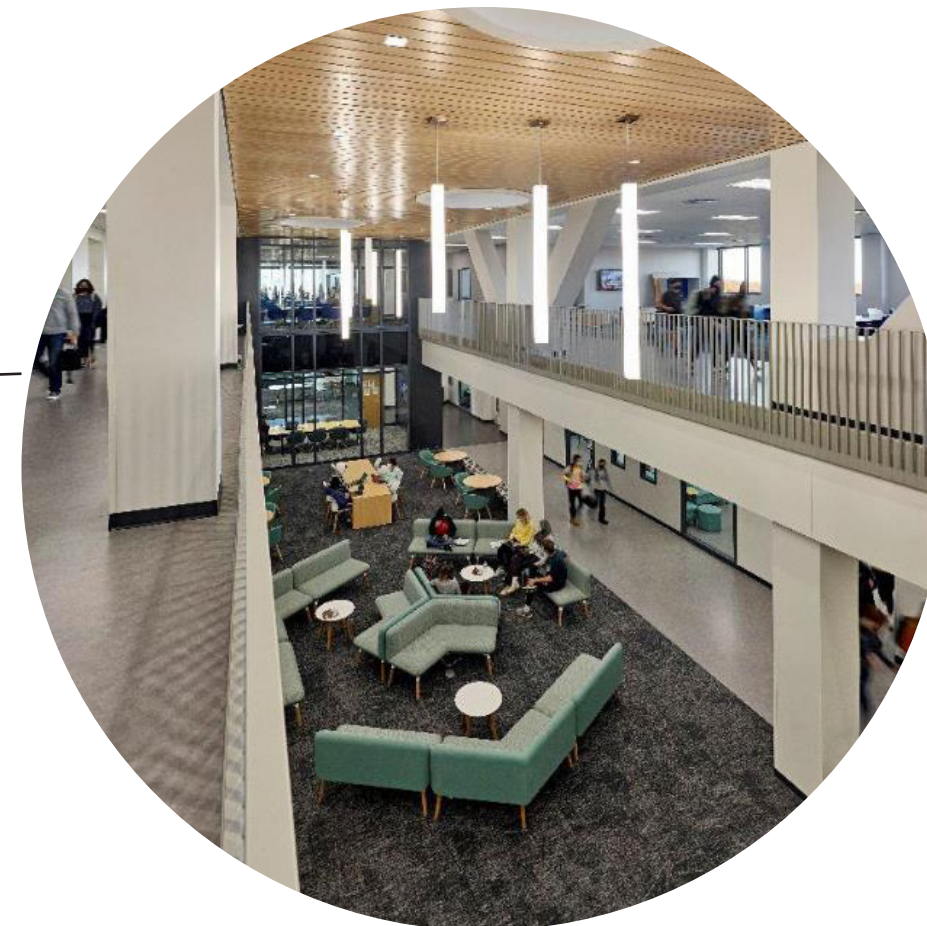
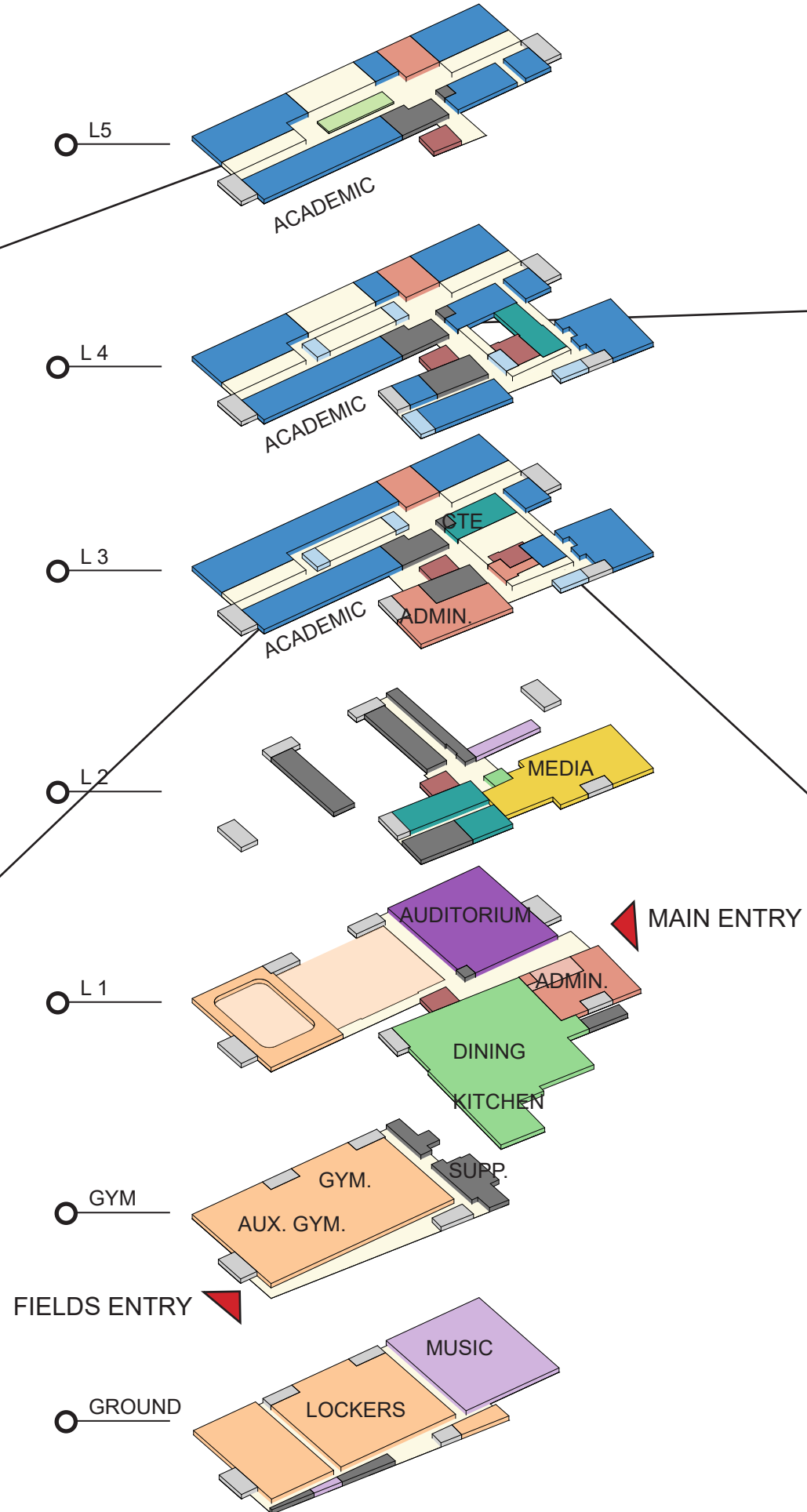

FCCPS MERIDIAN HIGH SCHOOL



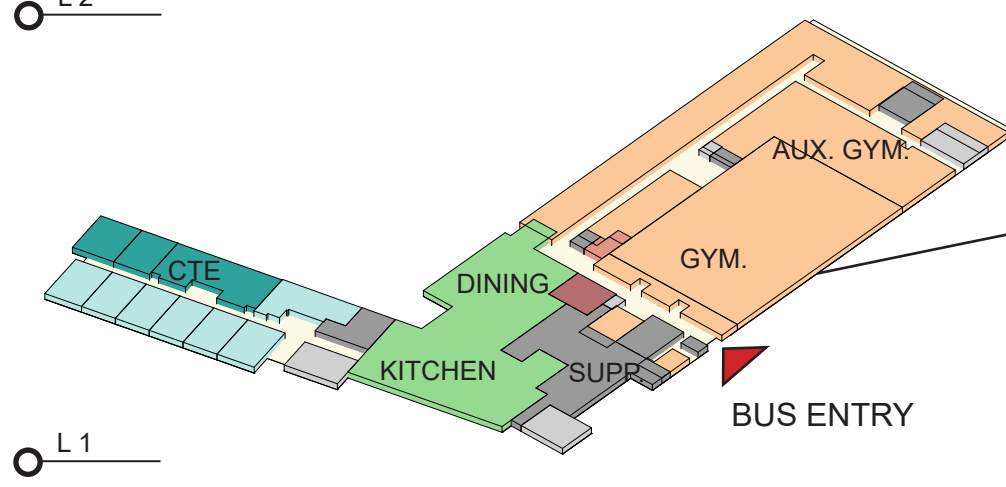
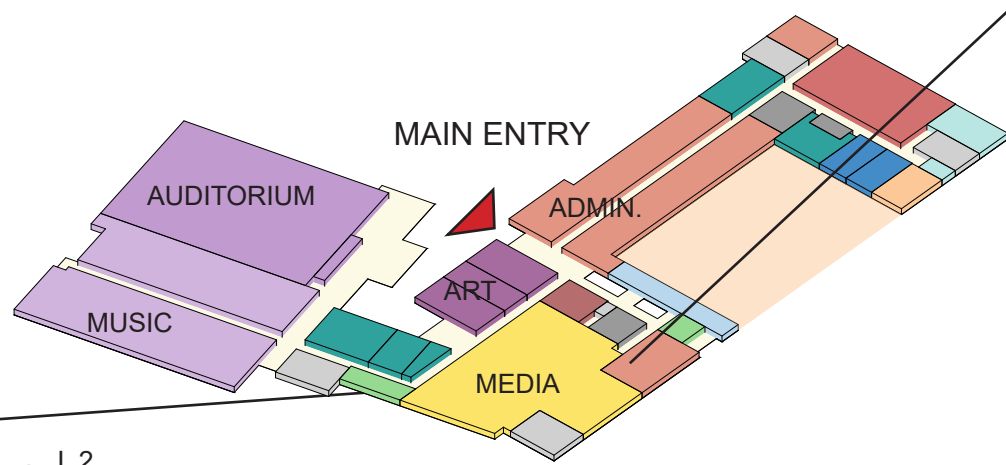
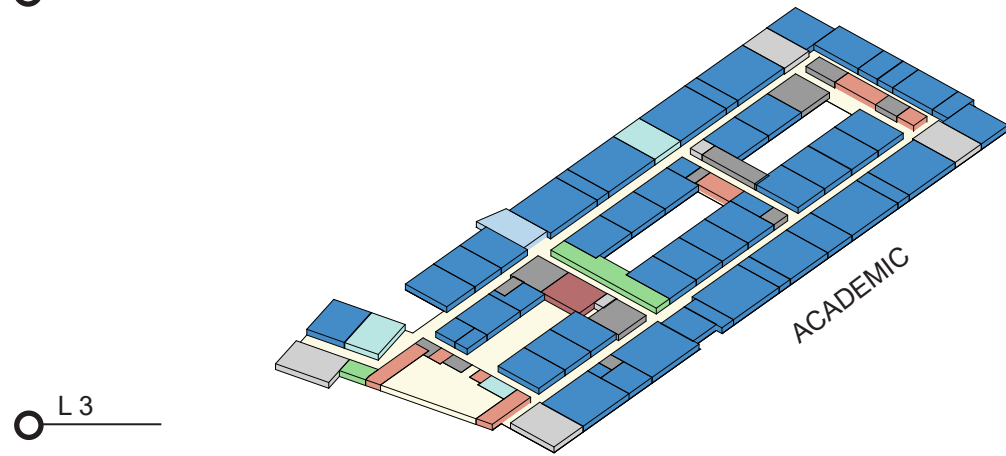
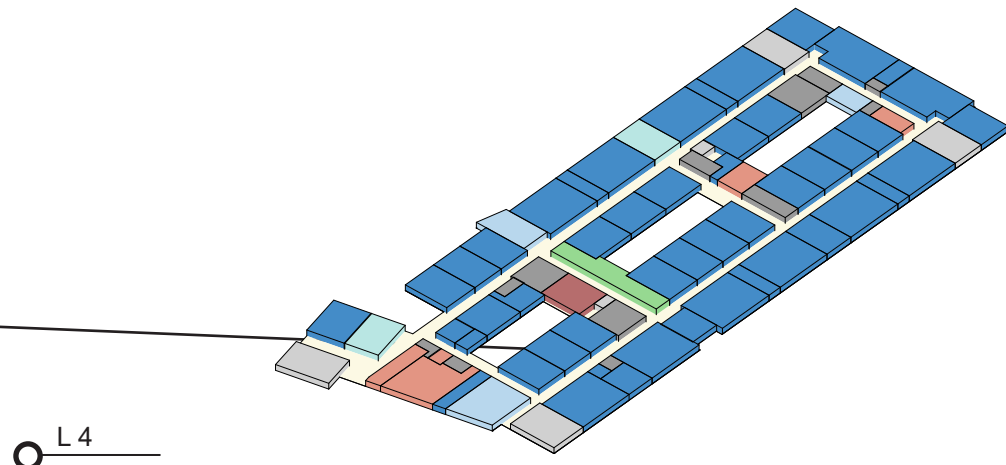

MCPS CROWN HIGH SCHOOL





# DISTRIBUTED PROGRAM

VERTICAL SCHOOLS TURNING CHALLENGES INTO OPPORTUNITIES





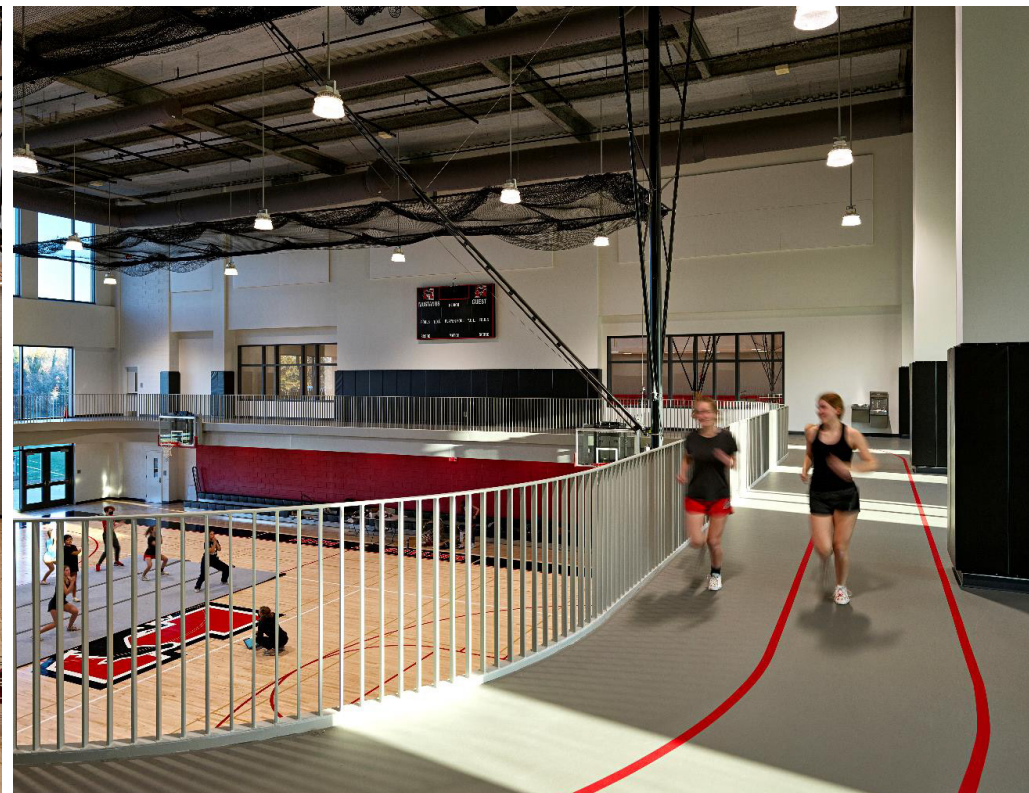
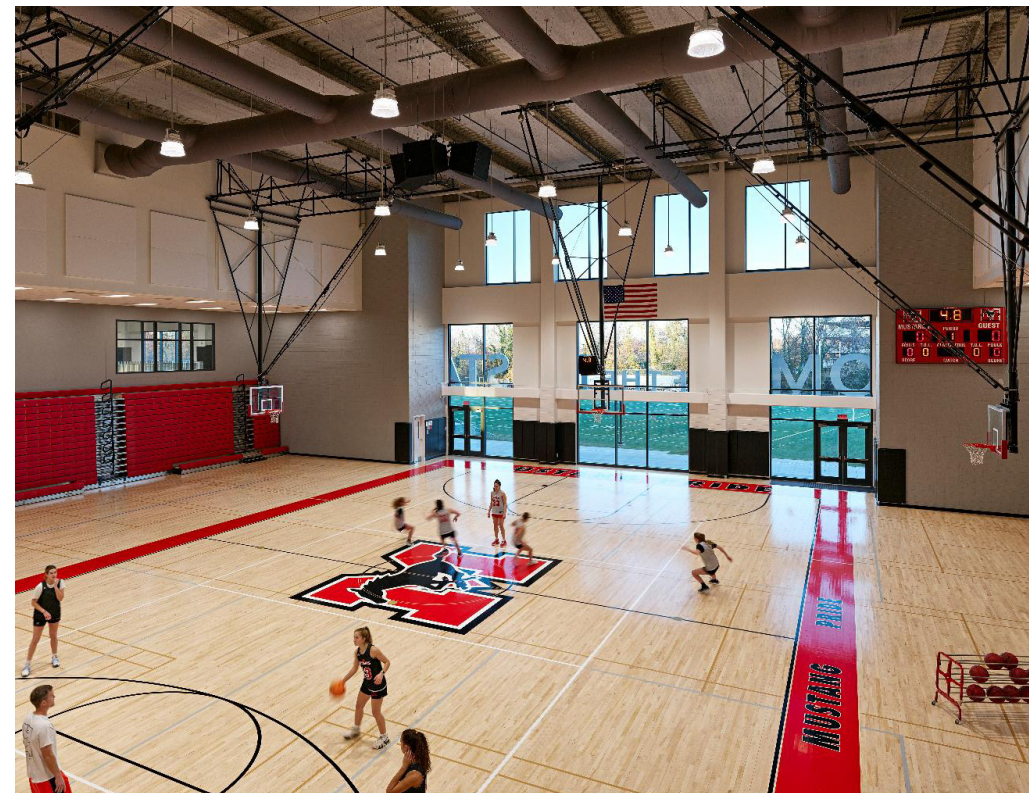
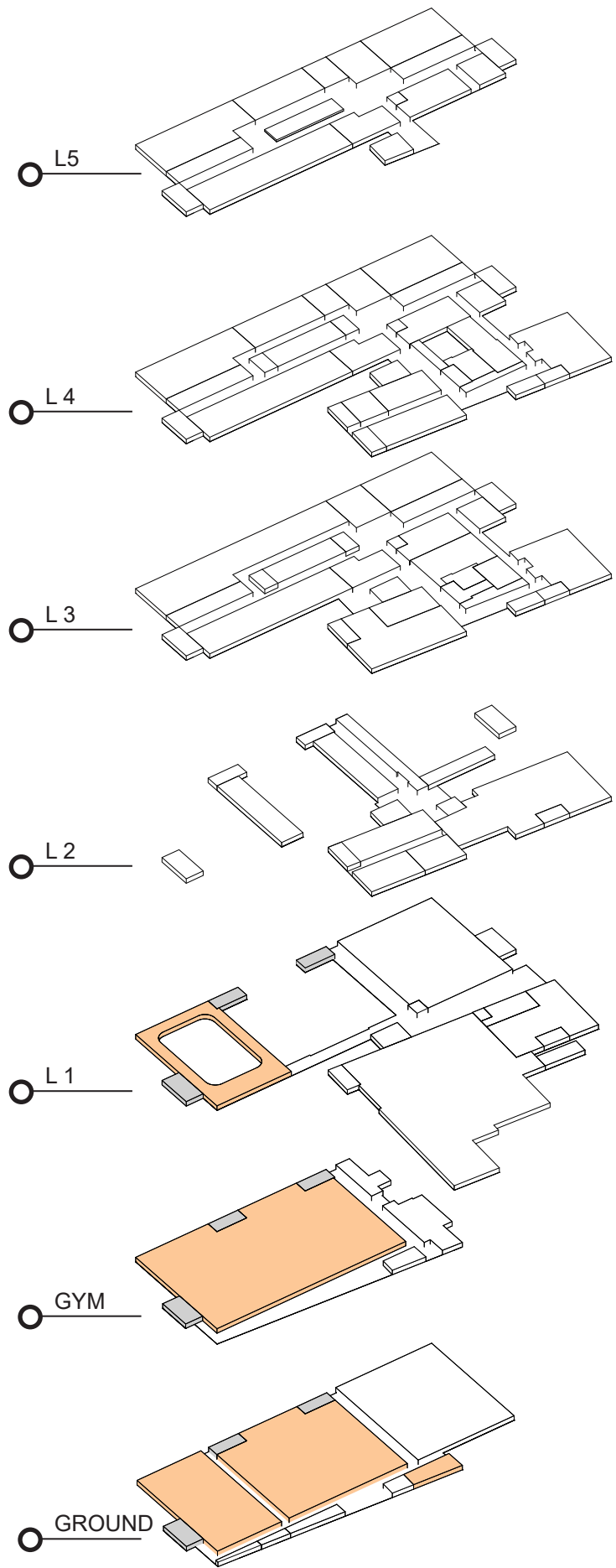

DISTRIBUTED PROGRAM DISTRIBUTED ATHLETICS

FCCPS MERIDIAN HIGH SCHOOL



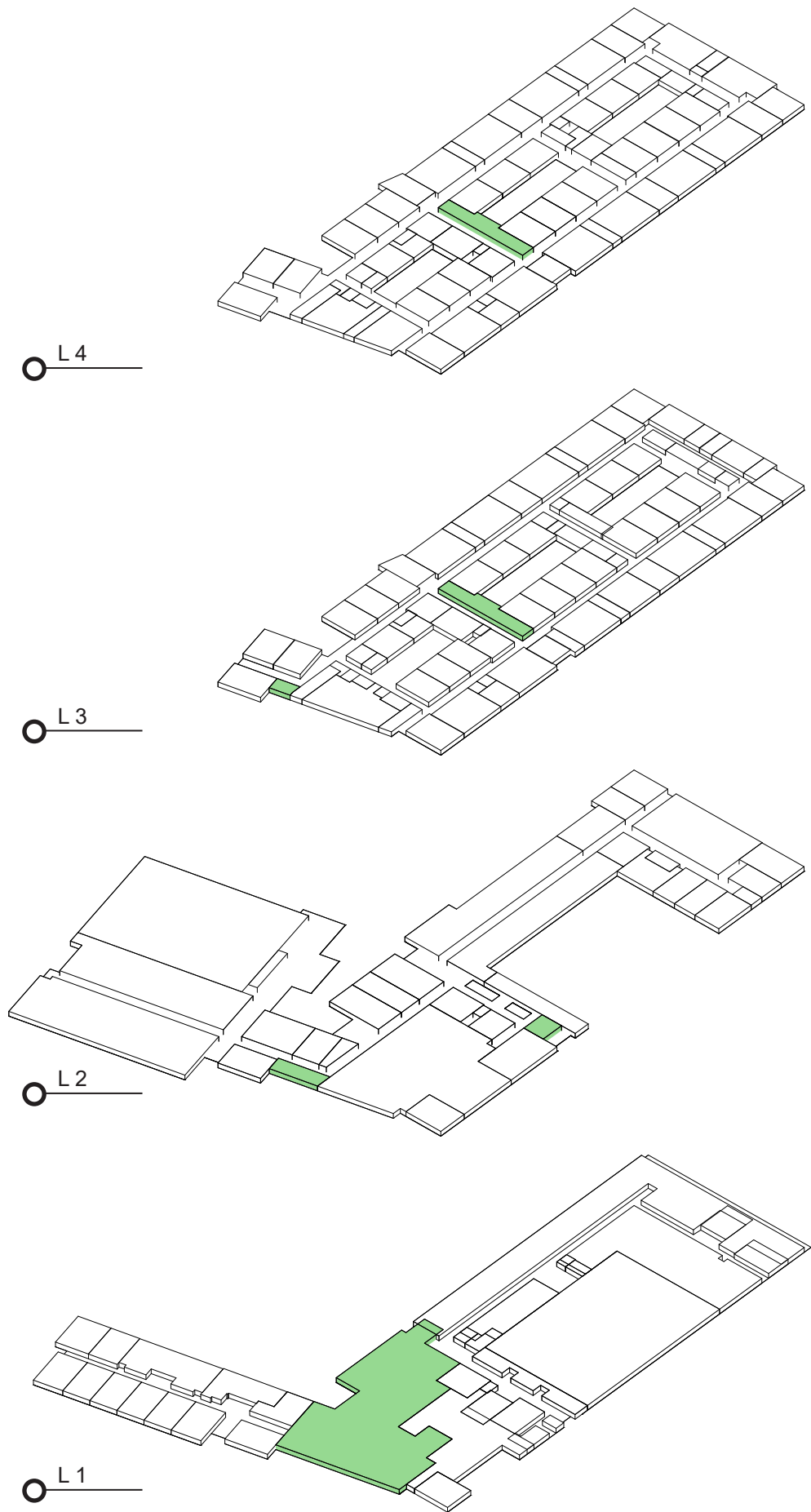

DISTRIBUTED PROGRAM DISTRIBUTED DINING



MCPS CROWN HIGH SCHOOL



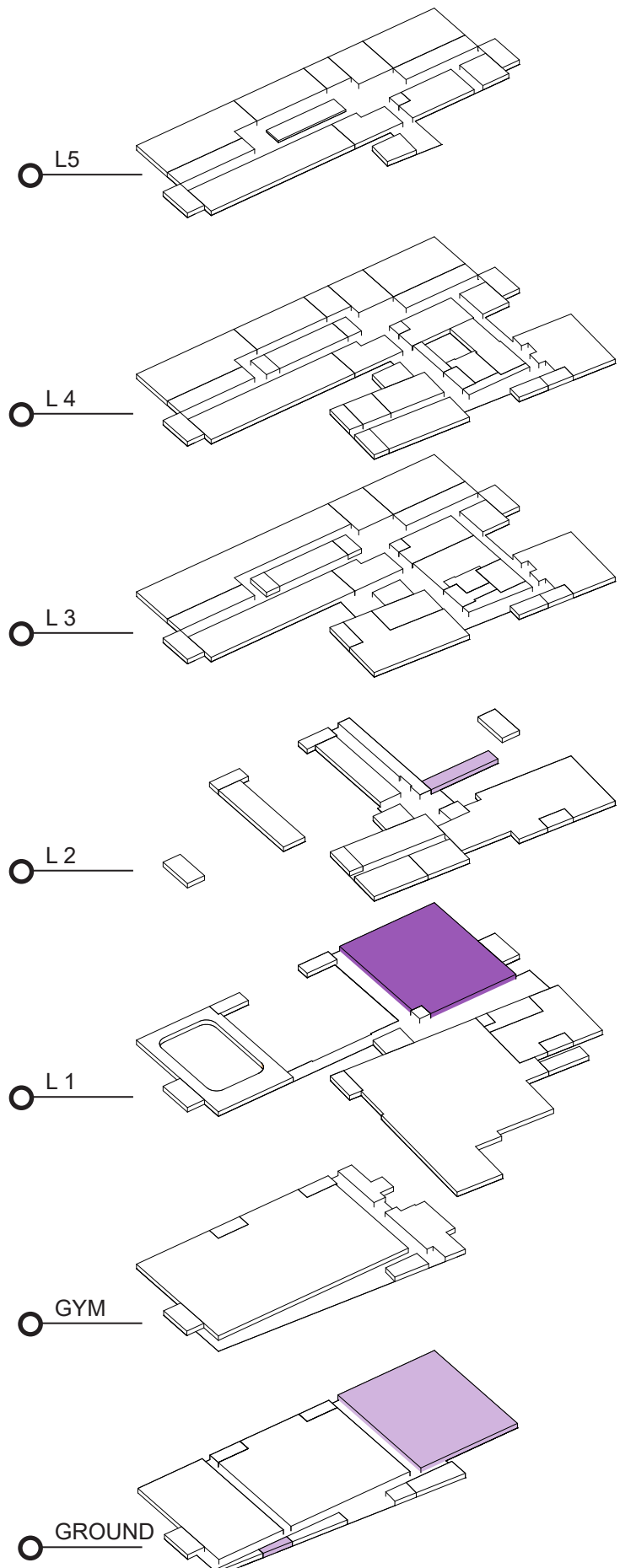

DISTRIBUTED PROGRAM DISTRIBUTED FINE ARTS

FCCPS MERIDIAN HIGH SCHOOL

VERTICAL SCHOOLS TURNING CHALLENGES INTO OPPORTUNITIES





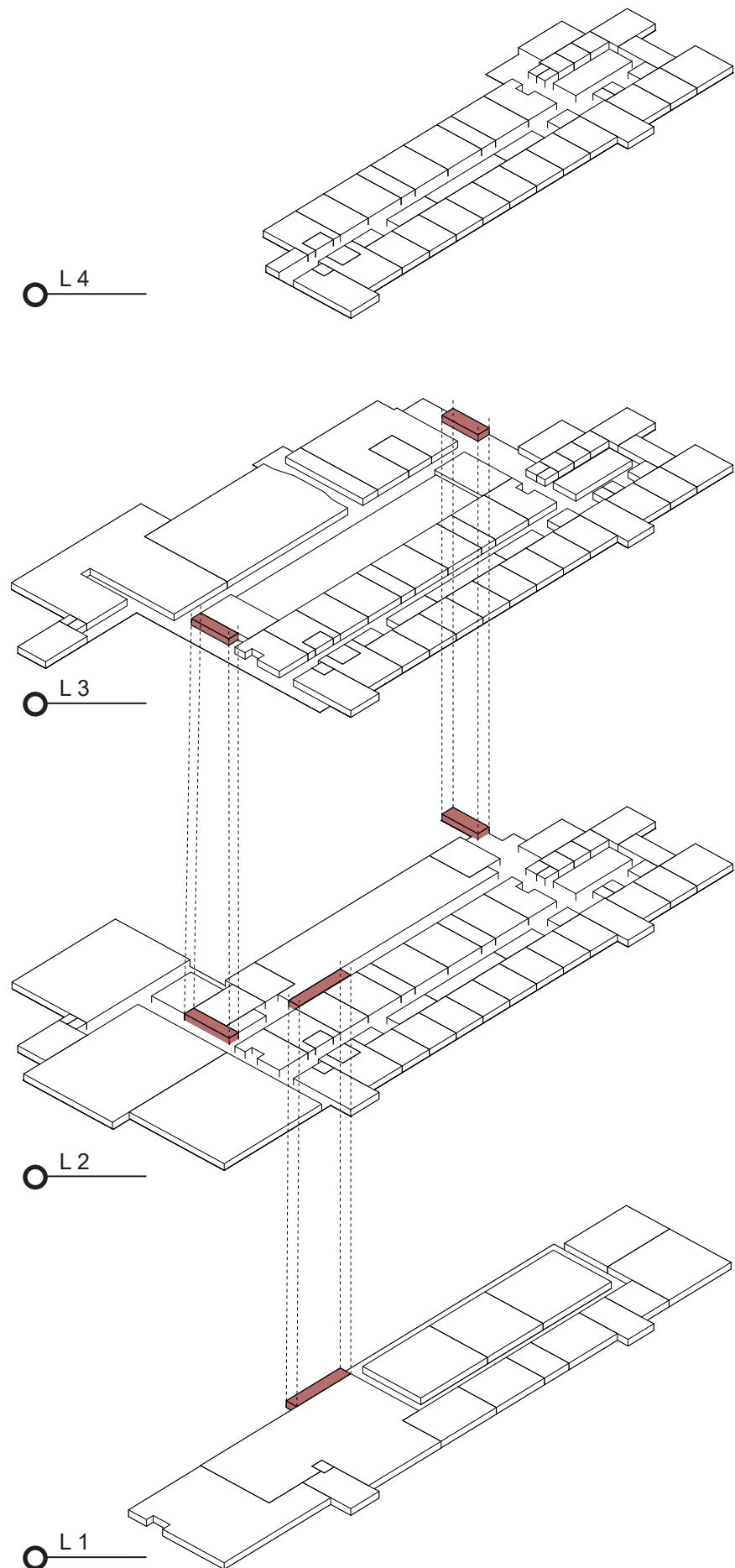

DISTRIBUTED PROGRAM VERTICAL CONNECTIONS



LCPS WATSON MOUNTAIN MIDDLE SCHOOL



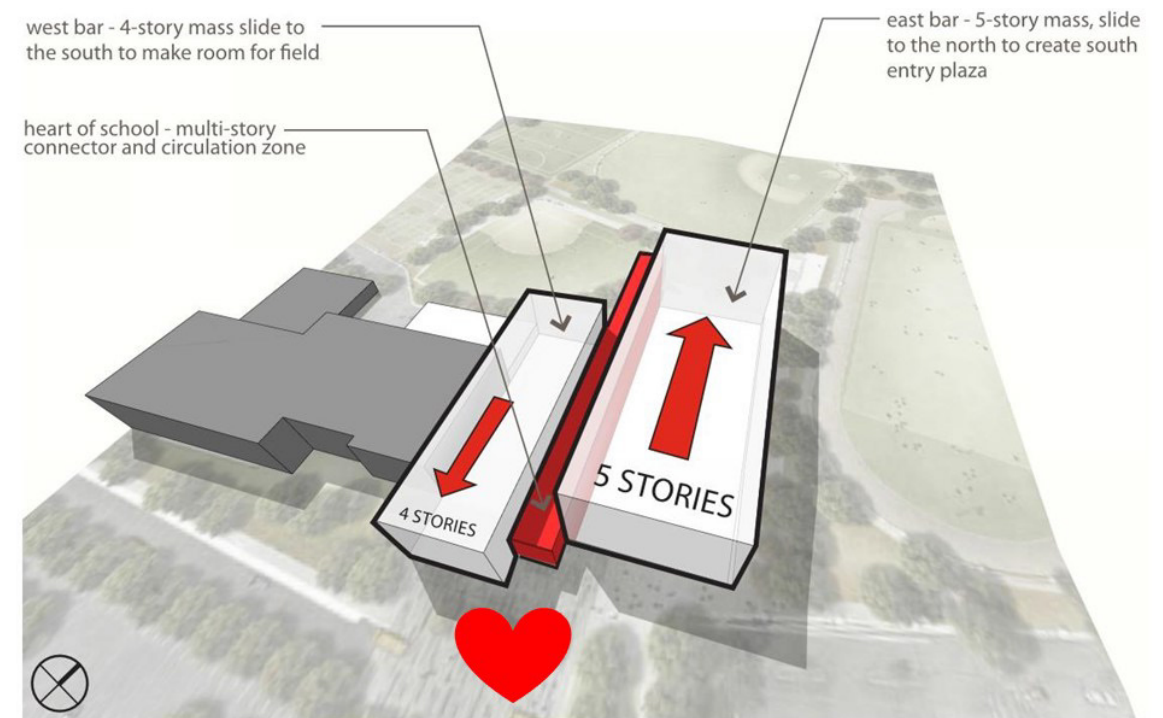
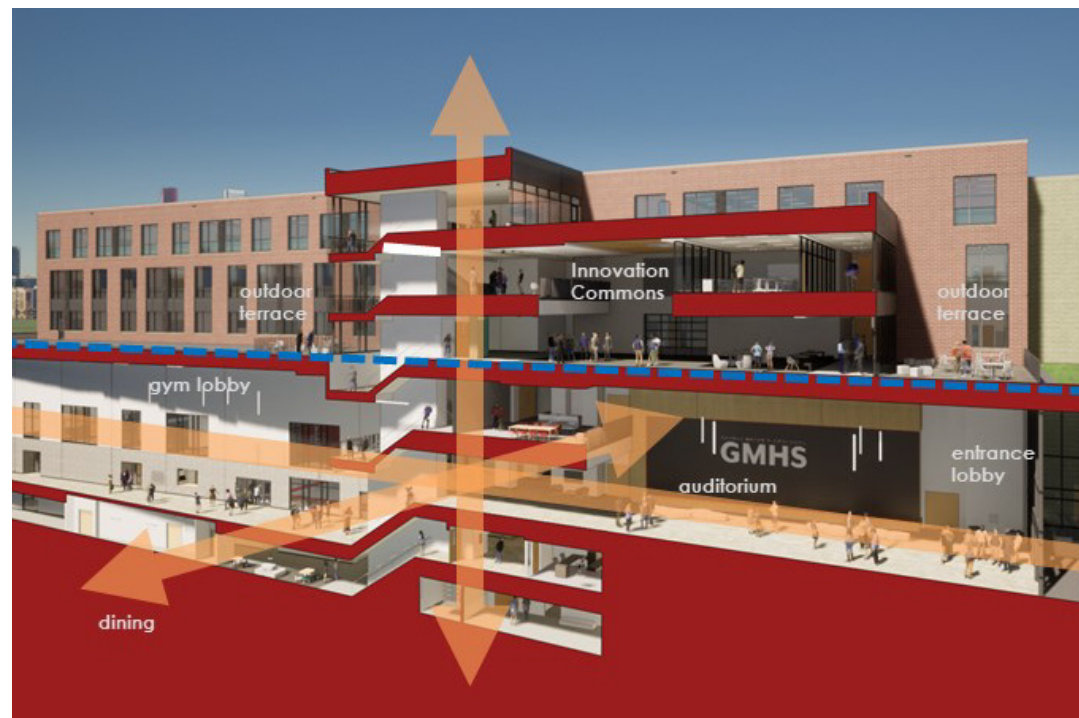
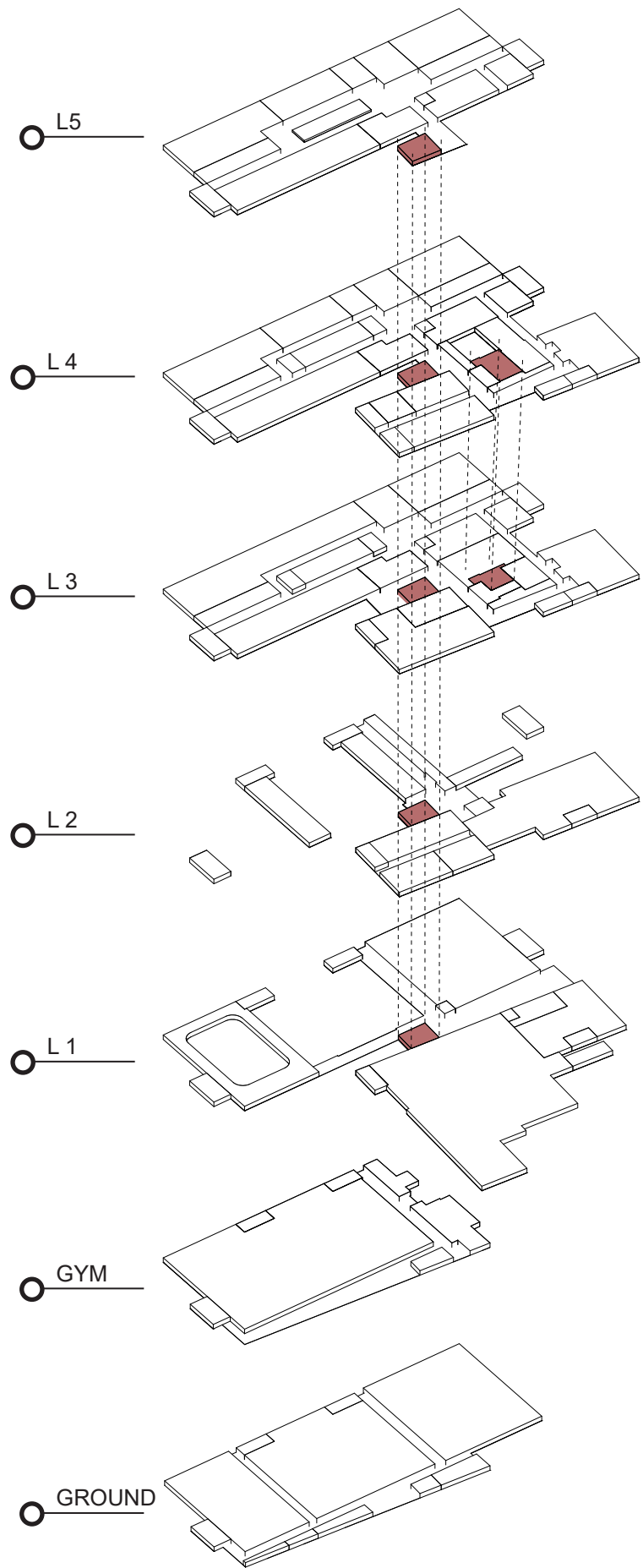

DISTRIBUTED PROGRAM VERTICAL CONNECTIONS

FCCPS MERIDIAN HIGH SCHOOL





# CIRCULATION & CODE

VERTICAL SCHOOLS TURNING CHALLENGES INTO OPPORTUNITIES





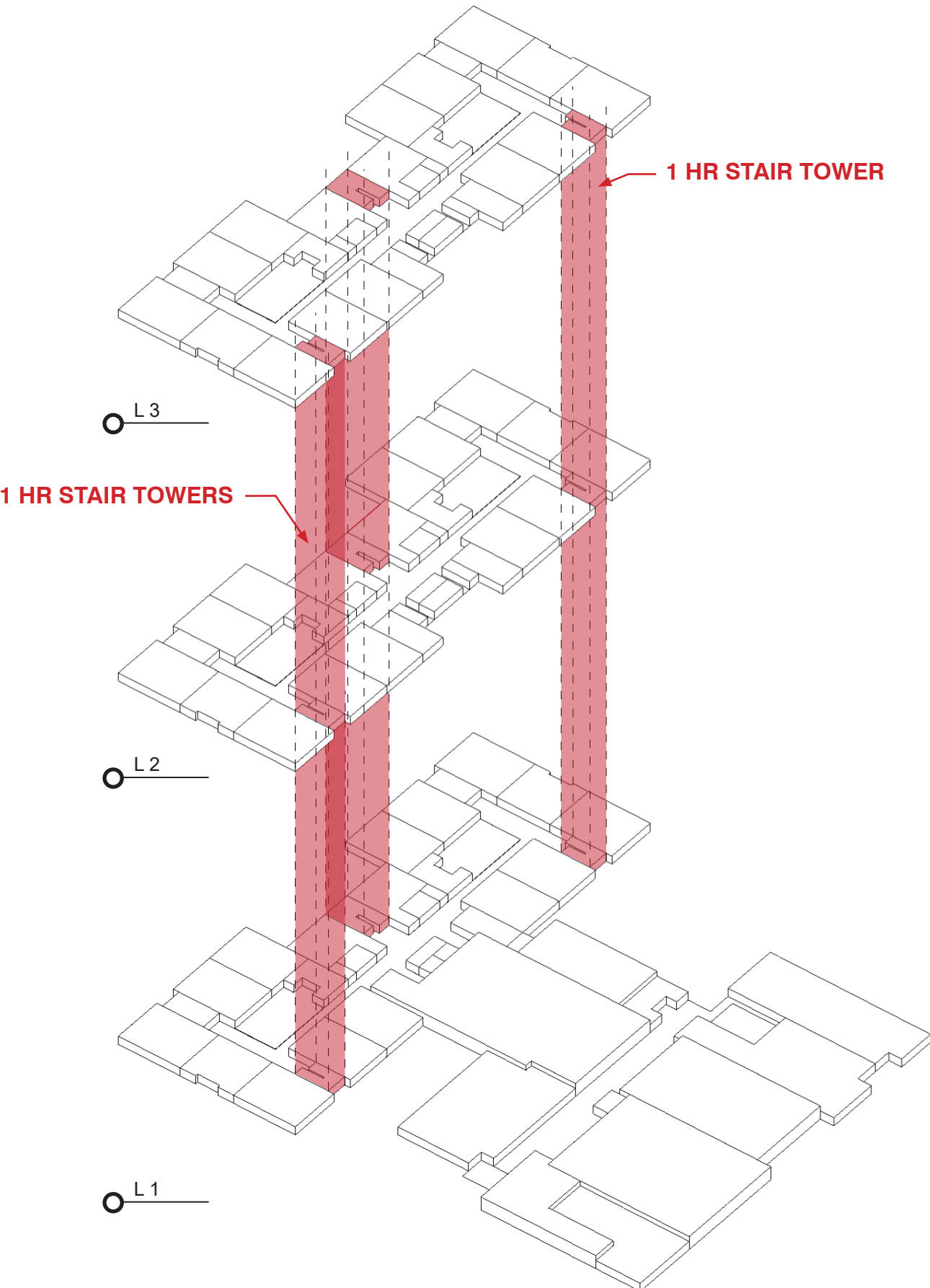

CODE & CIRCULATION

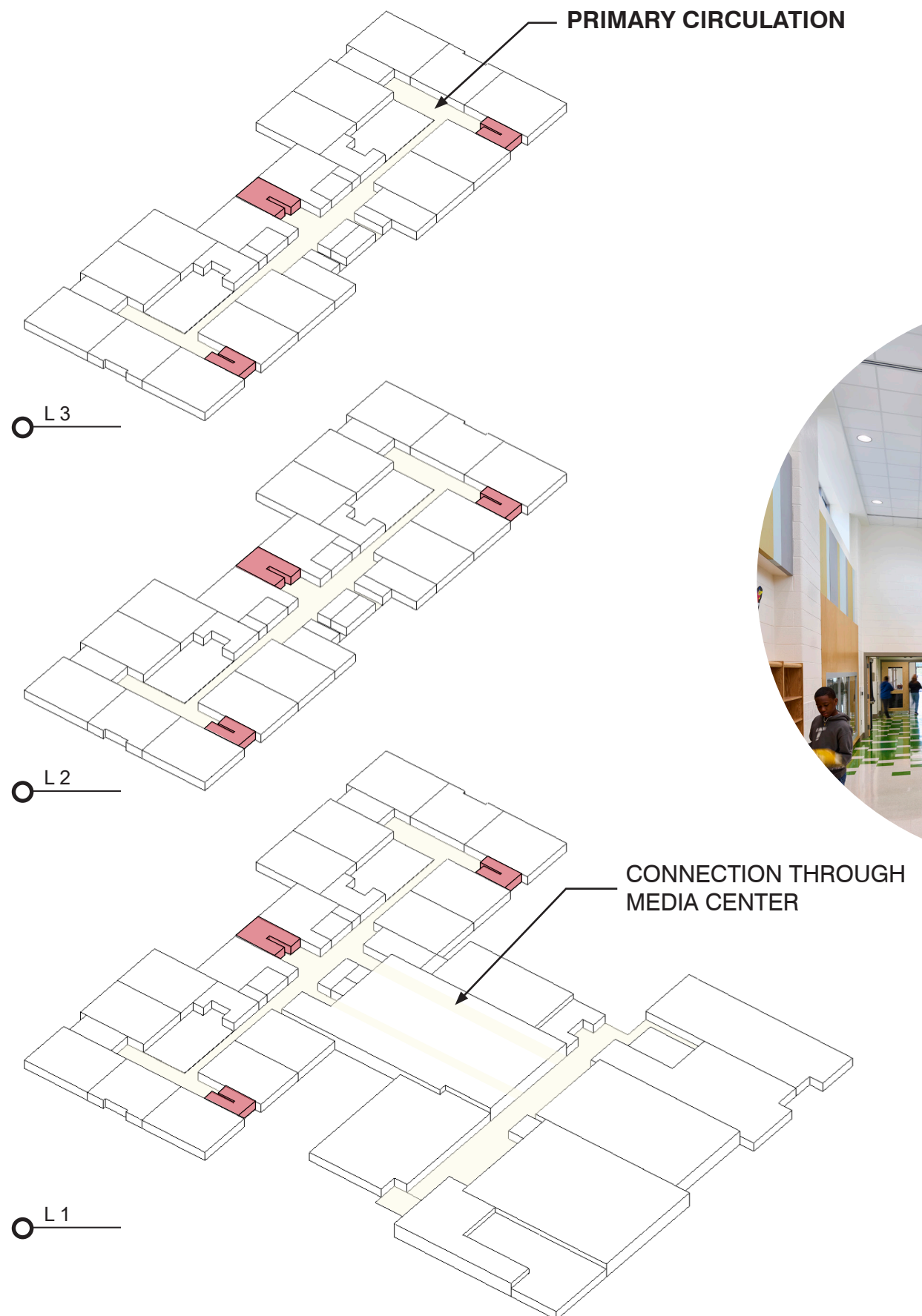

LCPS ELANE E. THOMPSON ELEMENTARY SCHOOL





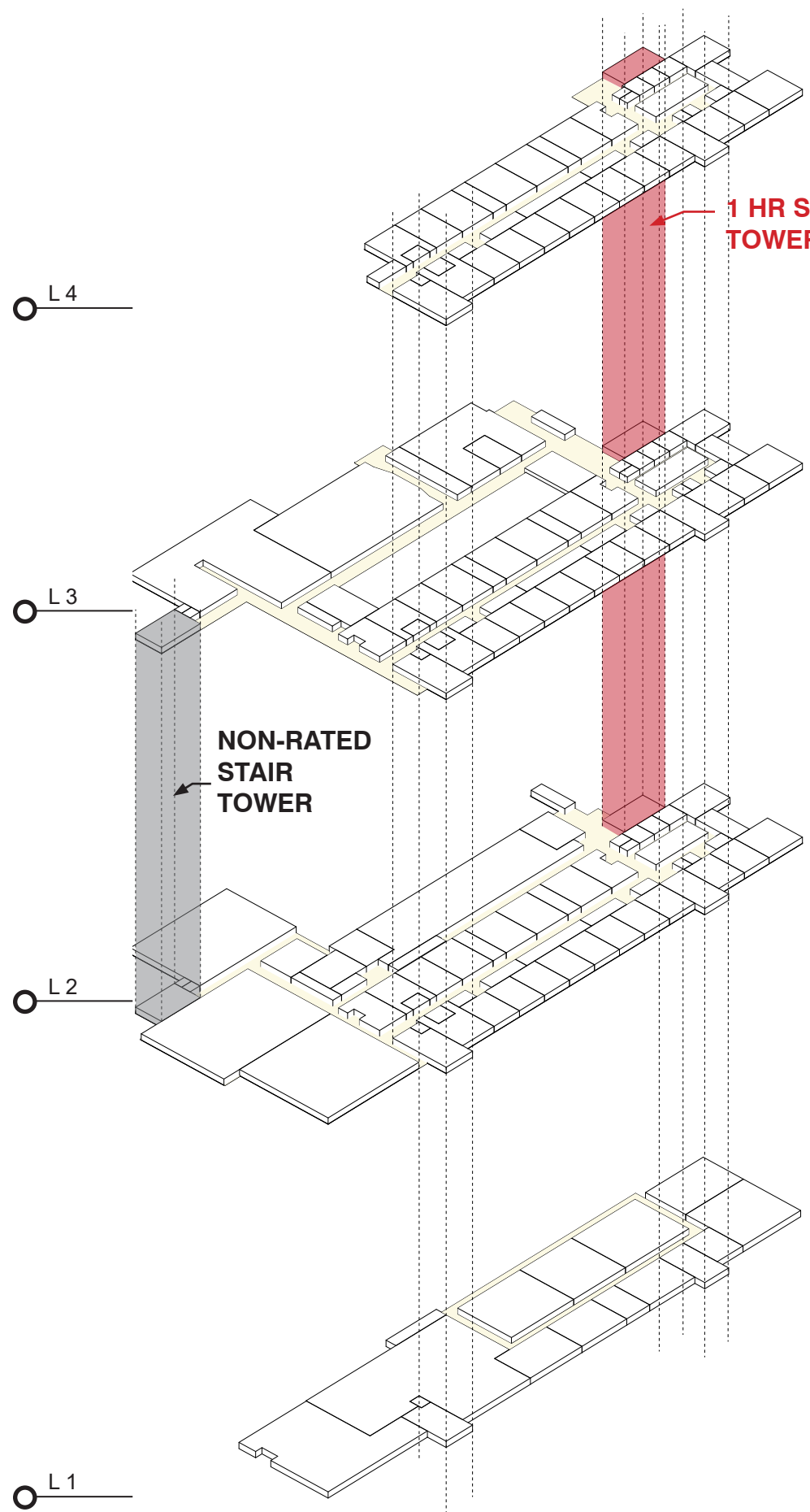

CODE & CIRCULATION

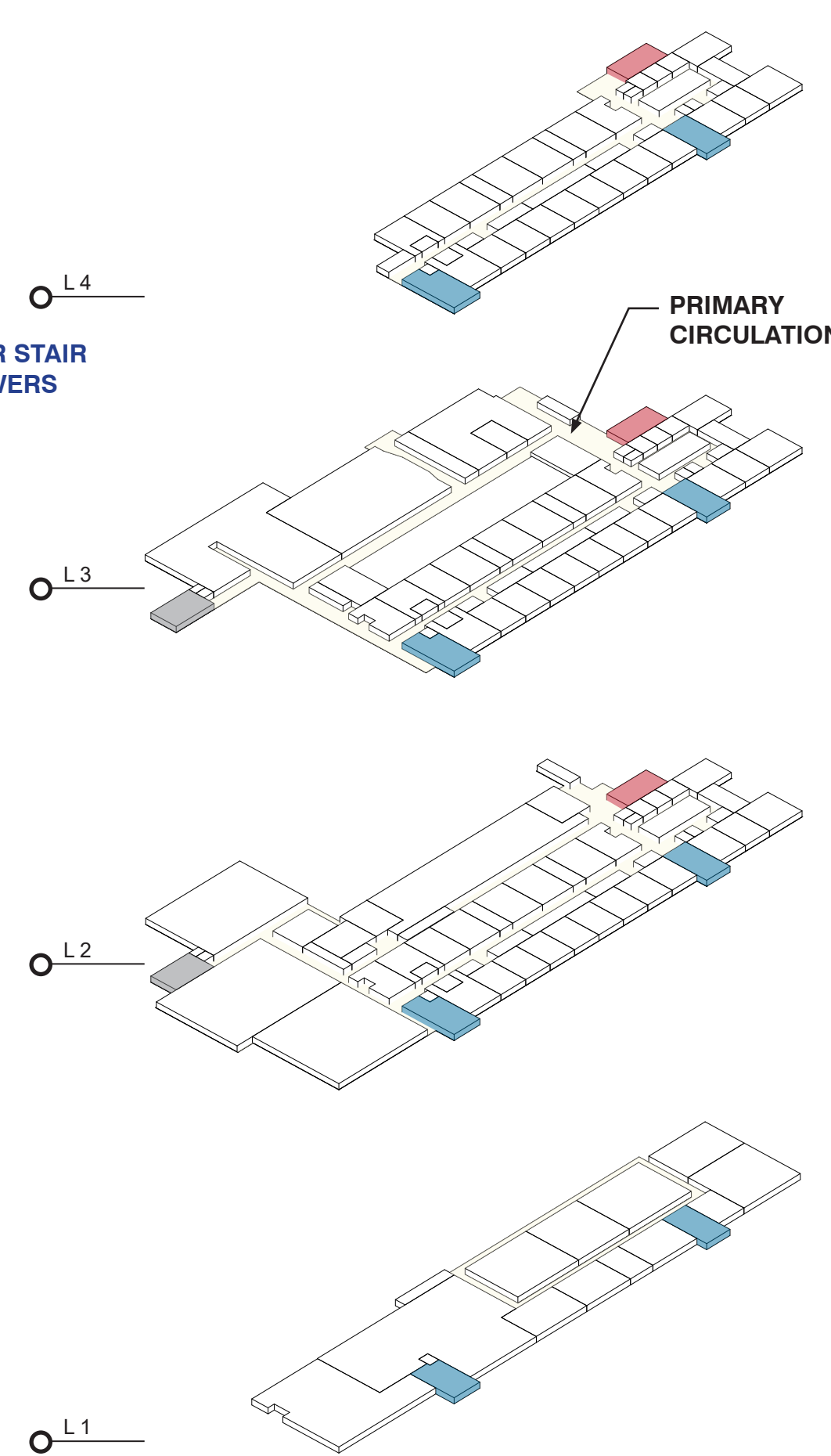
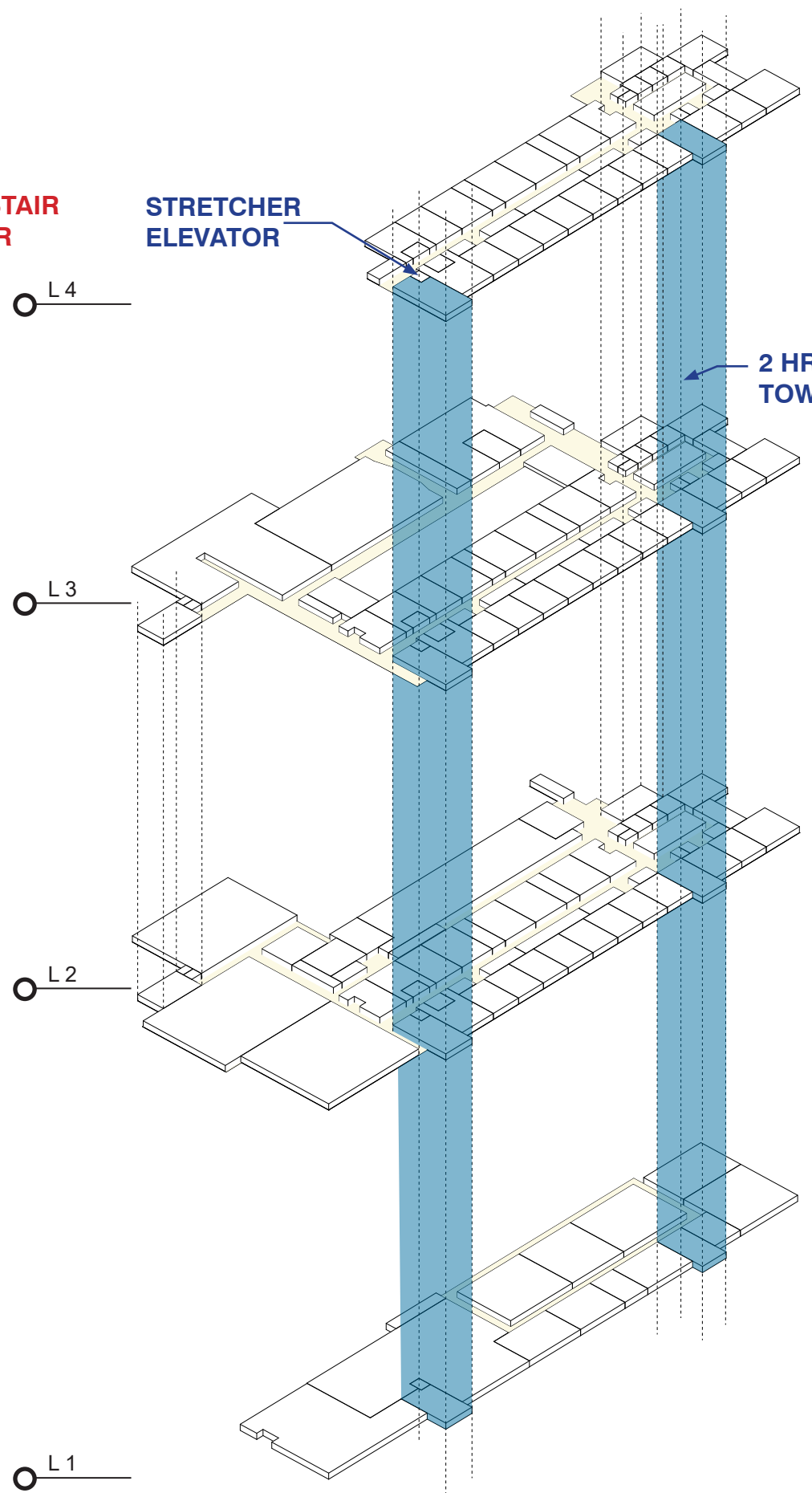

LCPS WATSON MOUNTAIN MIDDLE SCHOOL



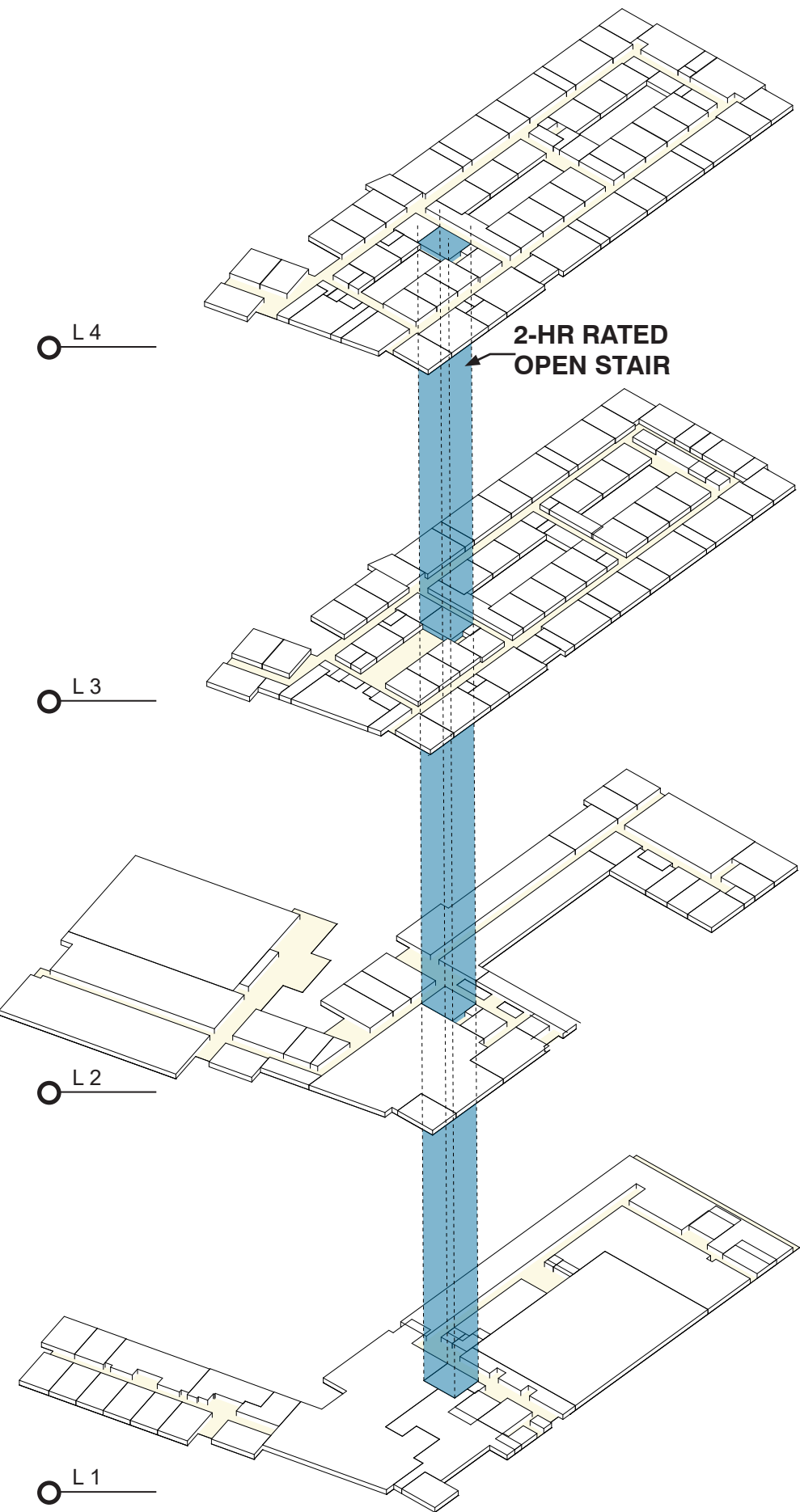

CODE & CIRCULATION

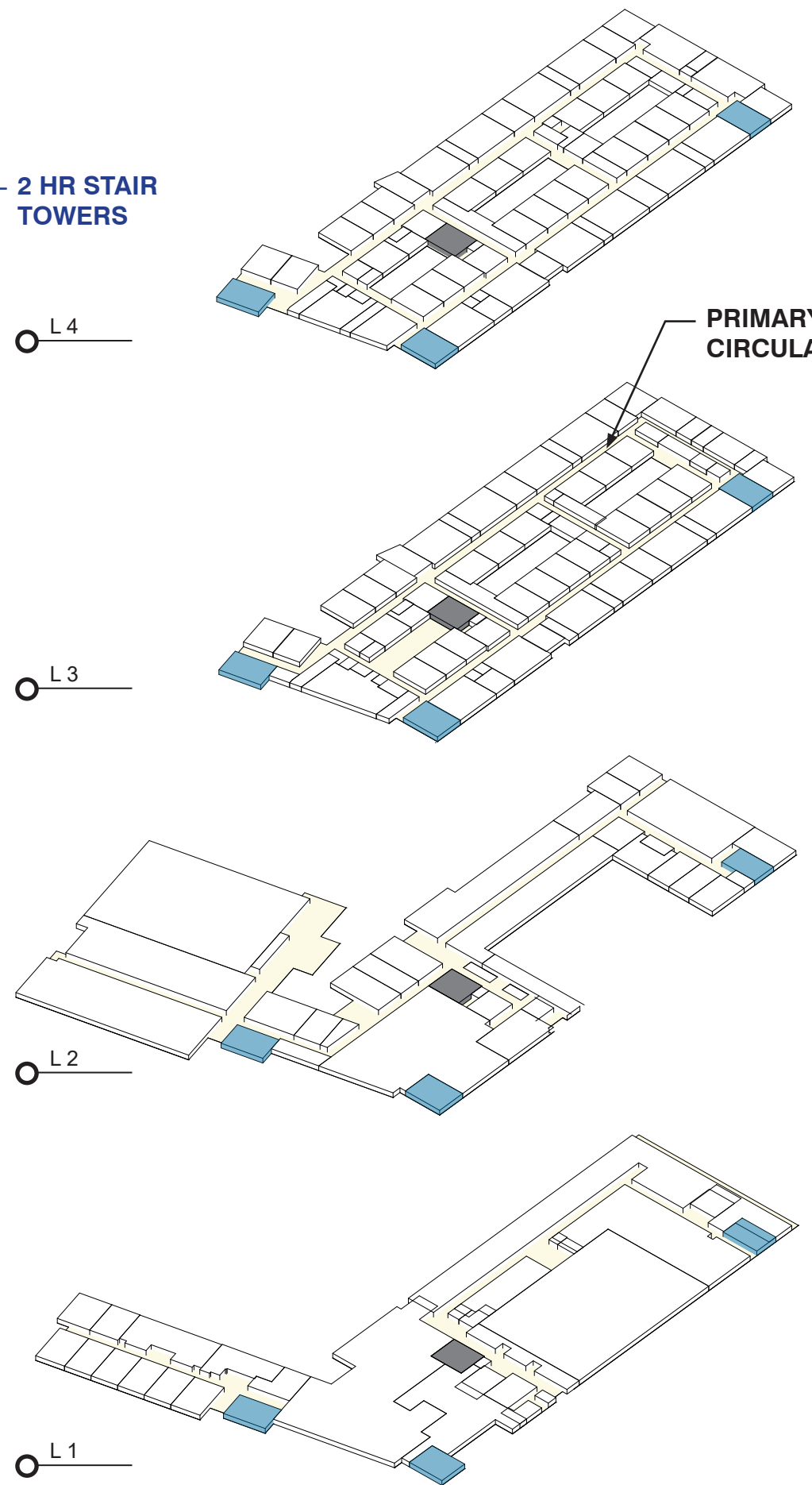
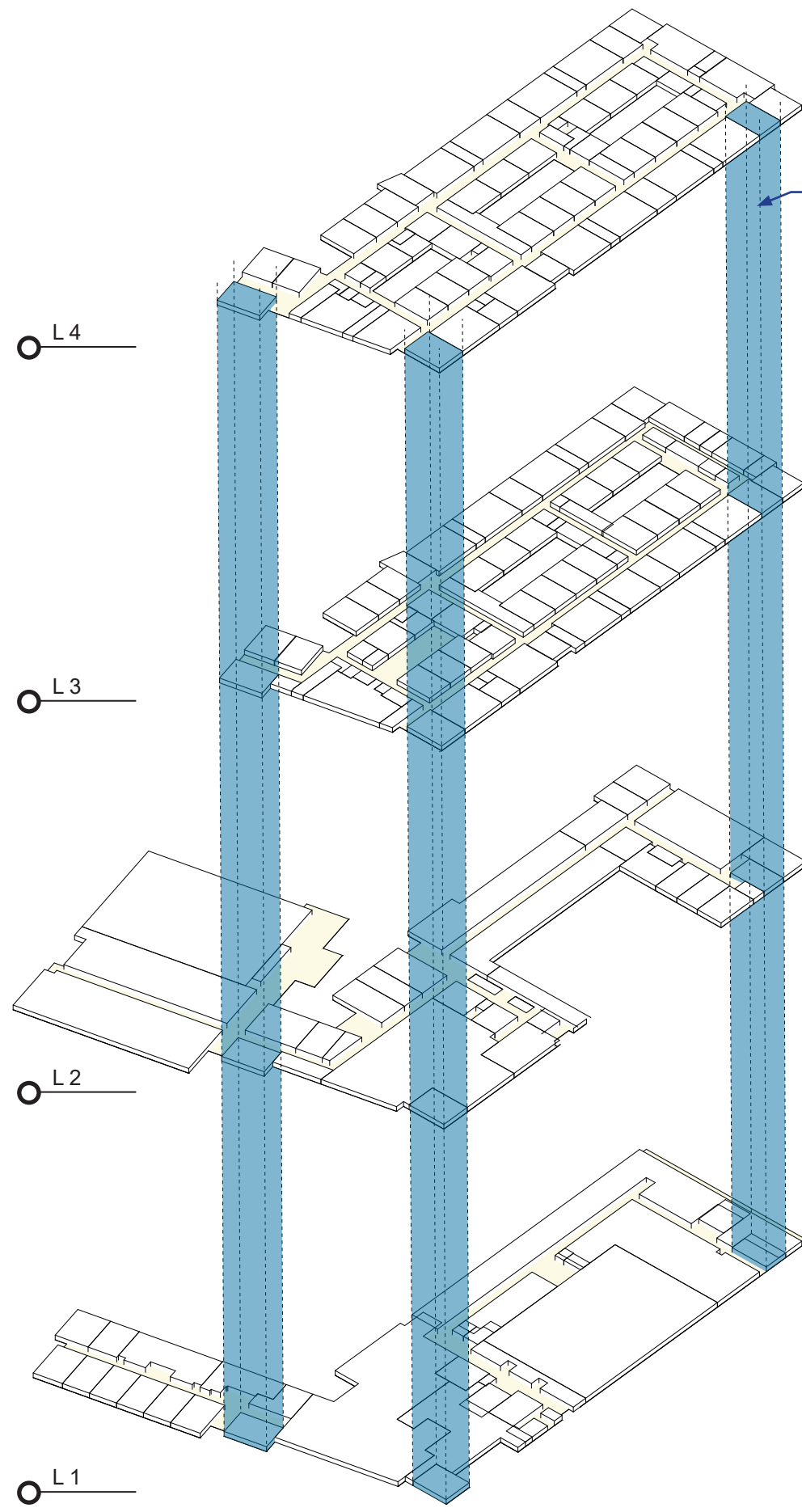

MCPS CROWN HIGH SCHOOL



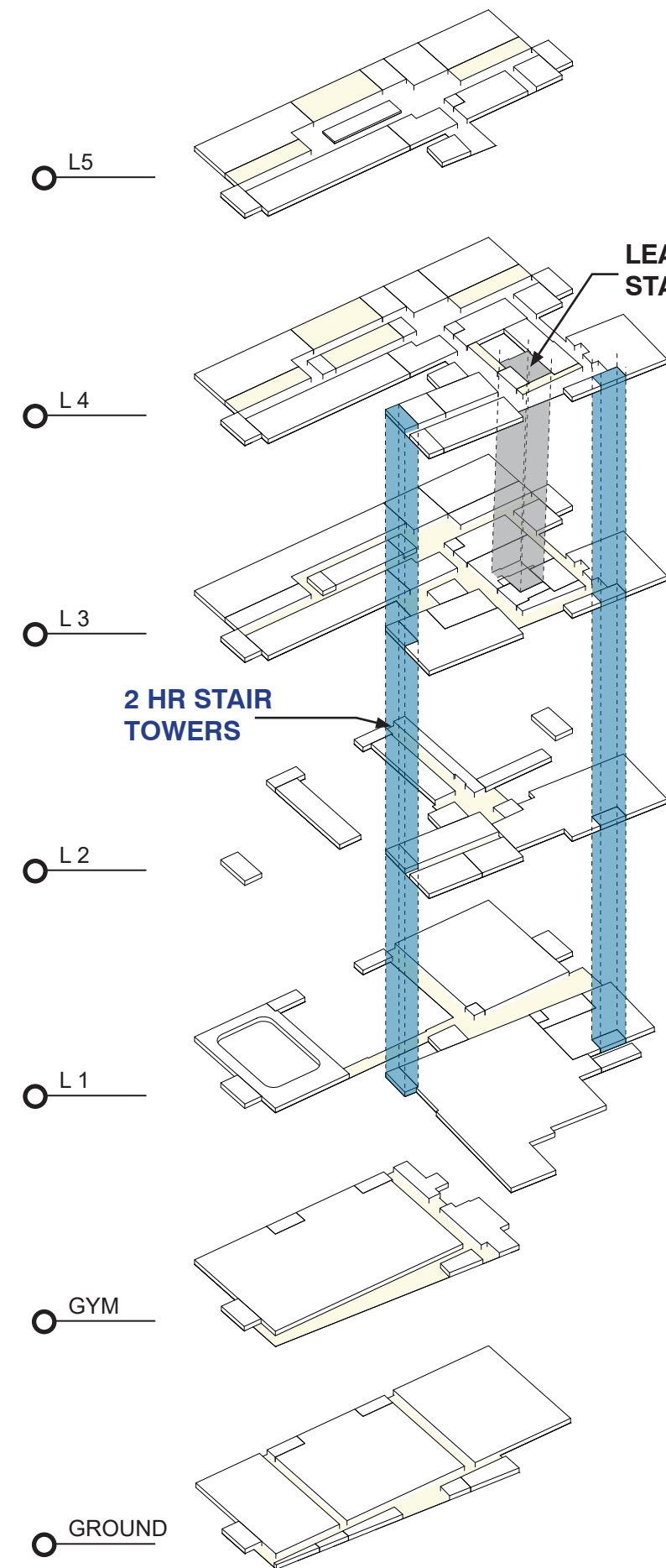

CODE & CIRCULATION

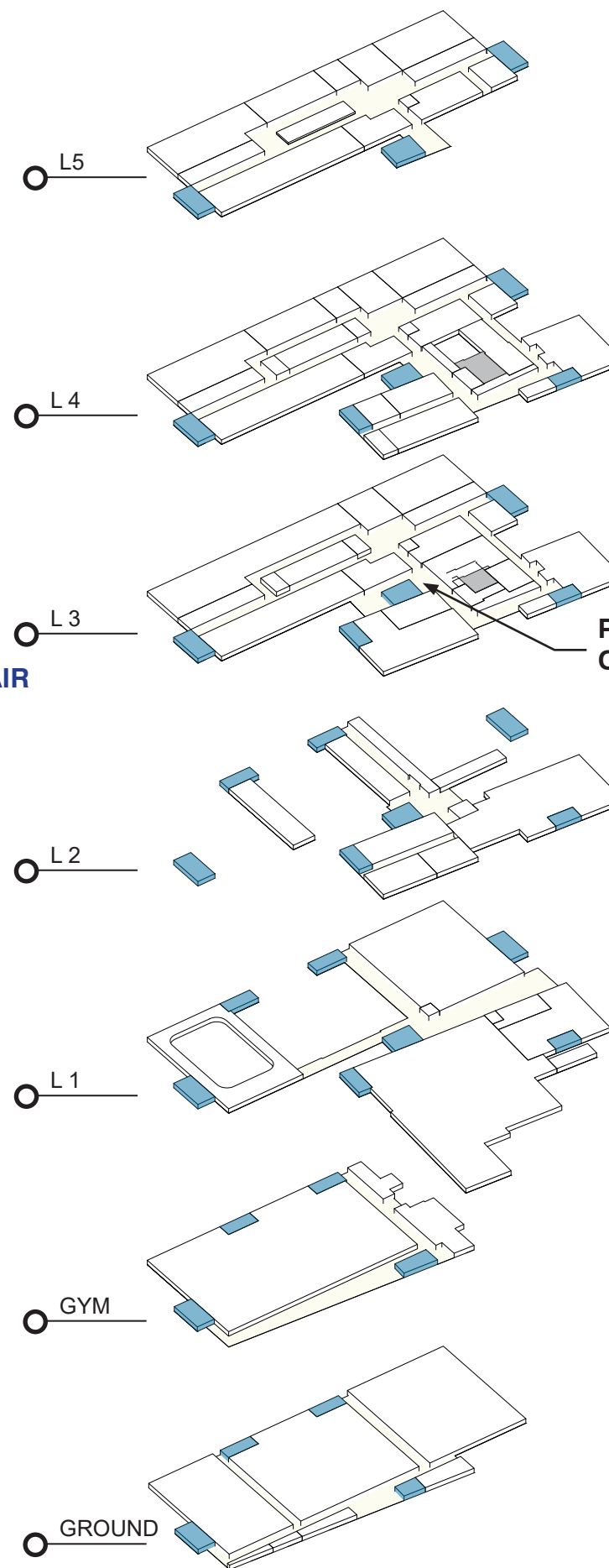
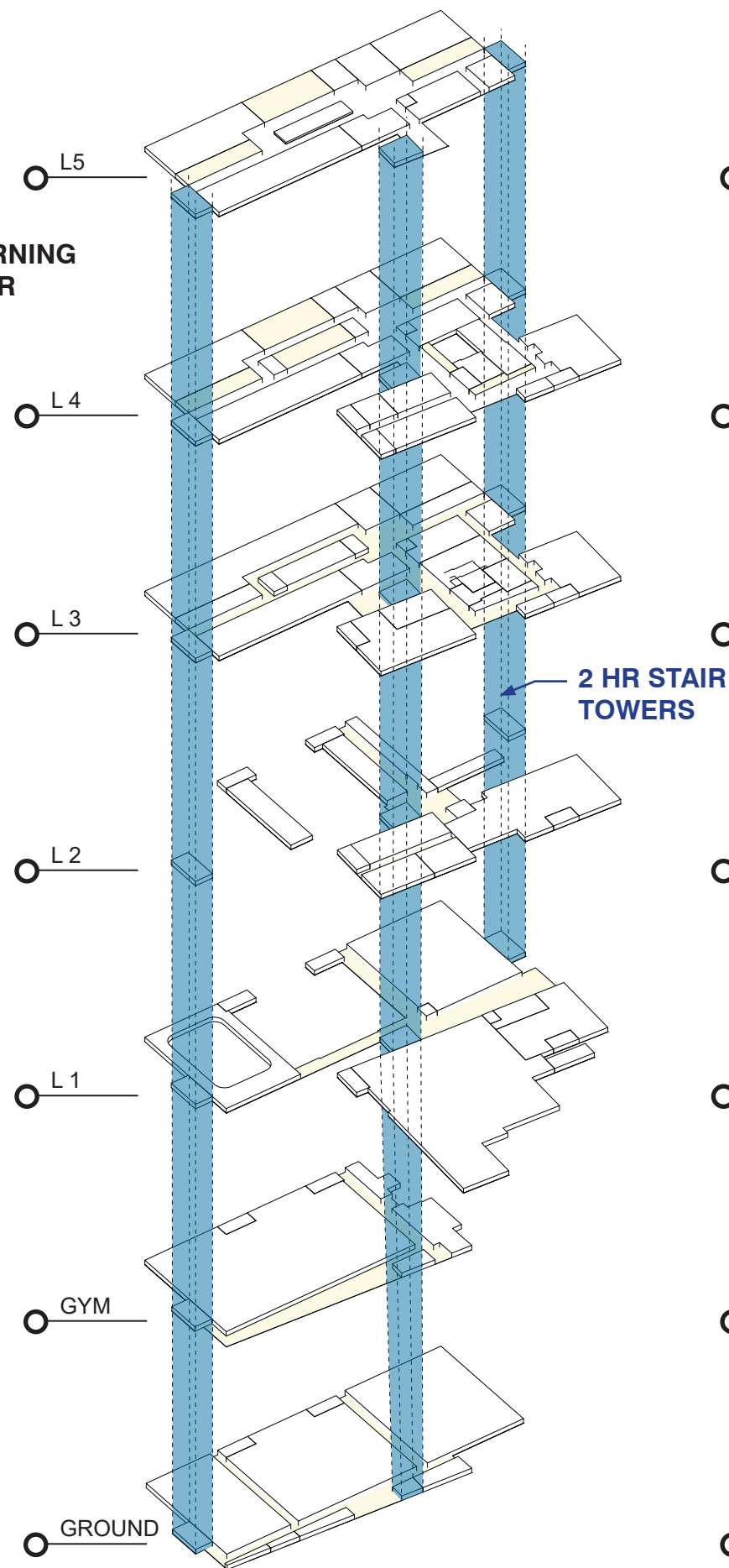

FCCPS MERIDIAN HIGH SCHOOL





# PUBLIC ACCESS AND SECURITY

VERTICAL SCHOOLS TURNING CHALLENGES INTO OPPORTUNITIES









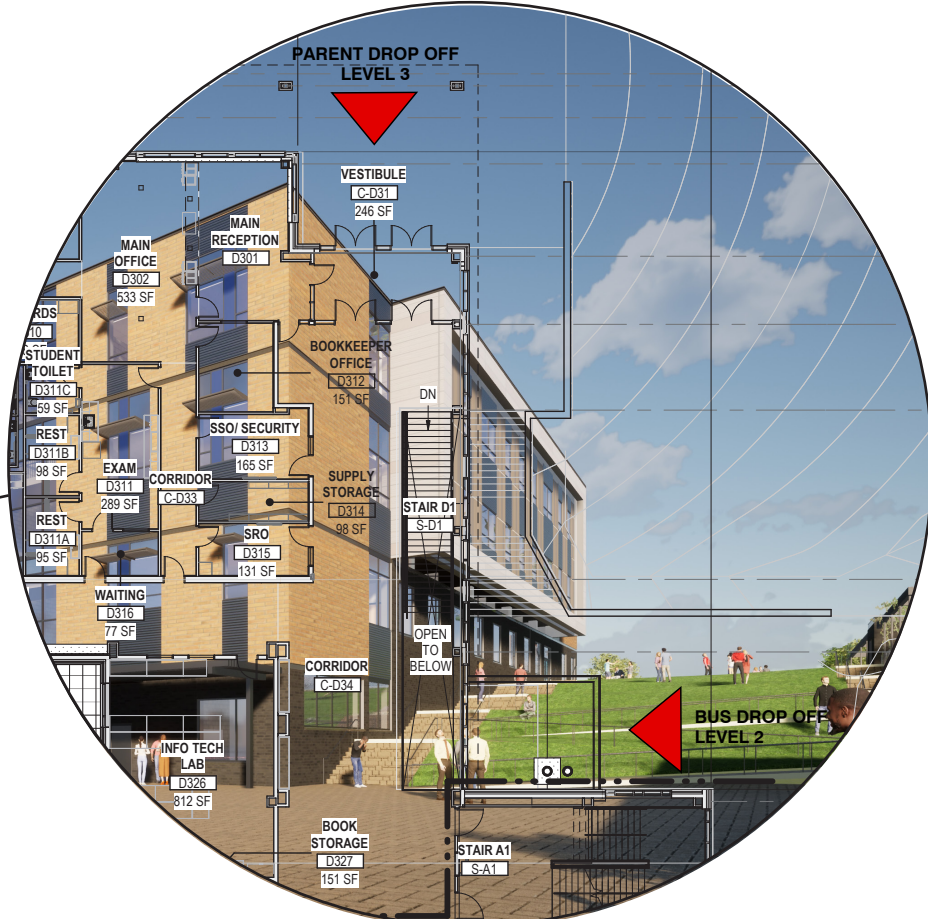
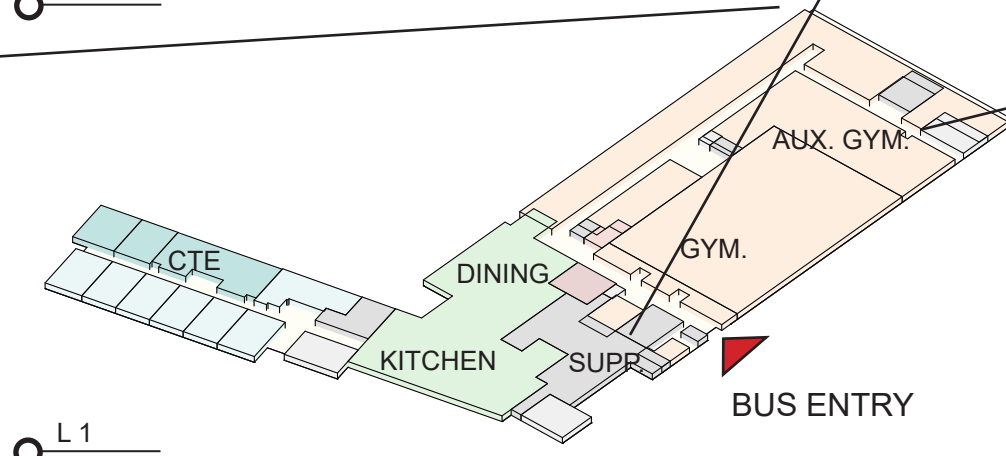
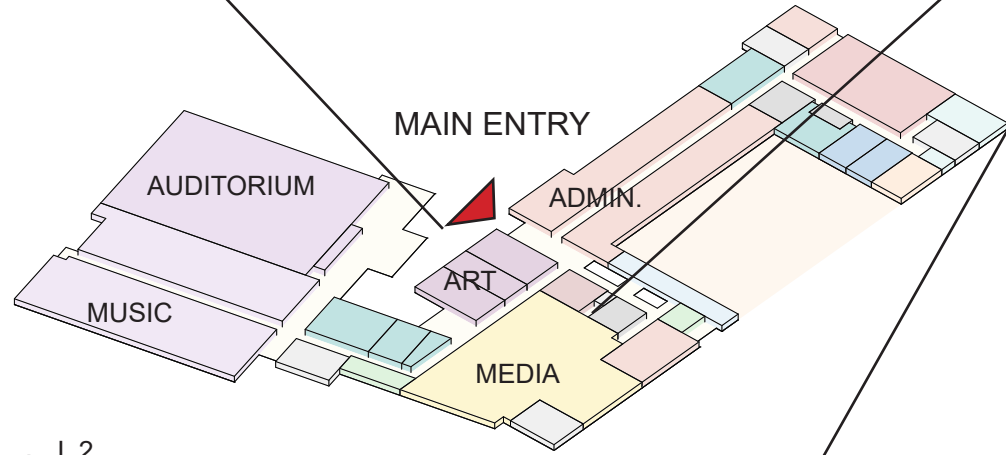
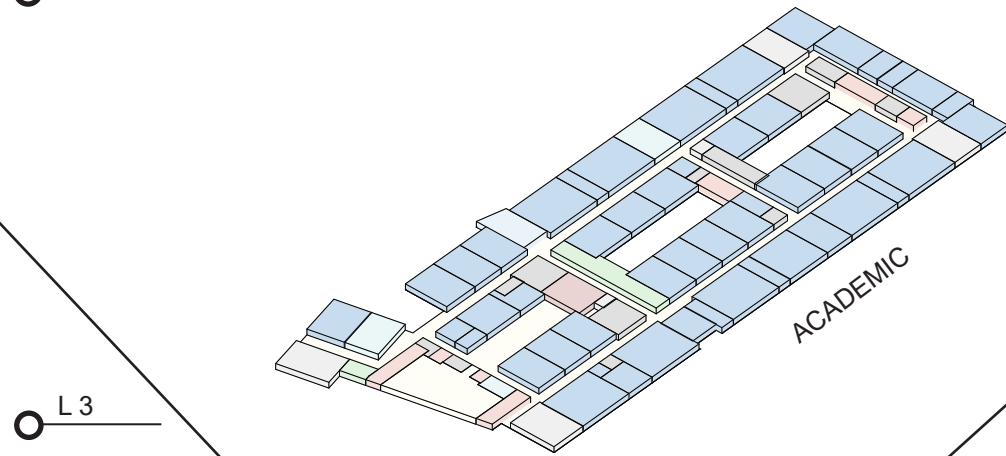
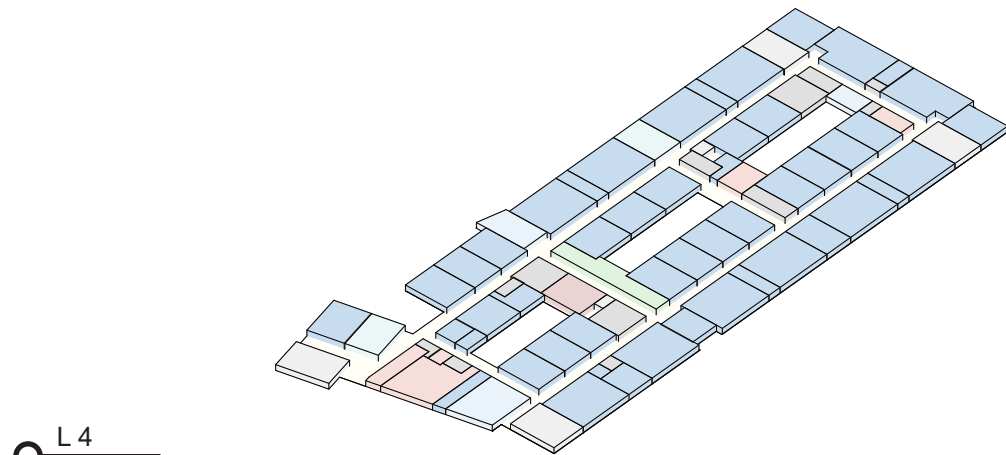

PUBLIC ACCESS

||||| LOCK DOWN DOORS

MCPS CROWN HIGH SCHOOL

VERTICAL SCHOOLS TURNING CHALLENGES INTO OPPORTUNITIES





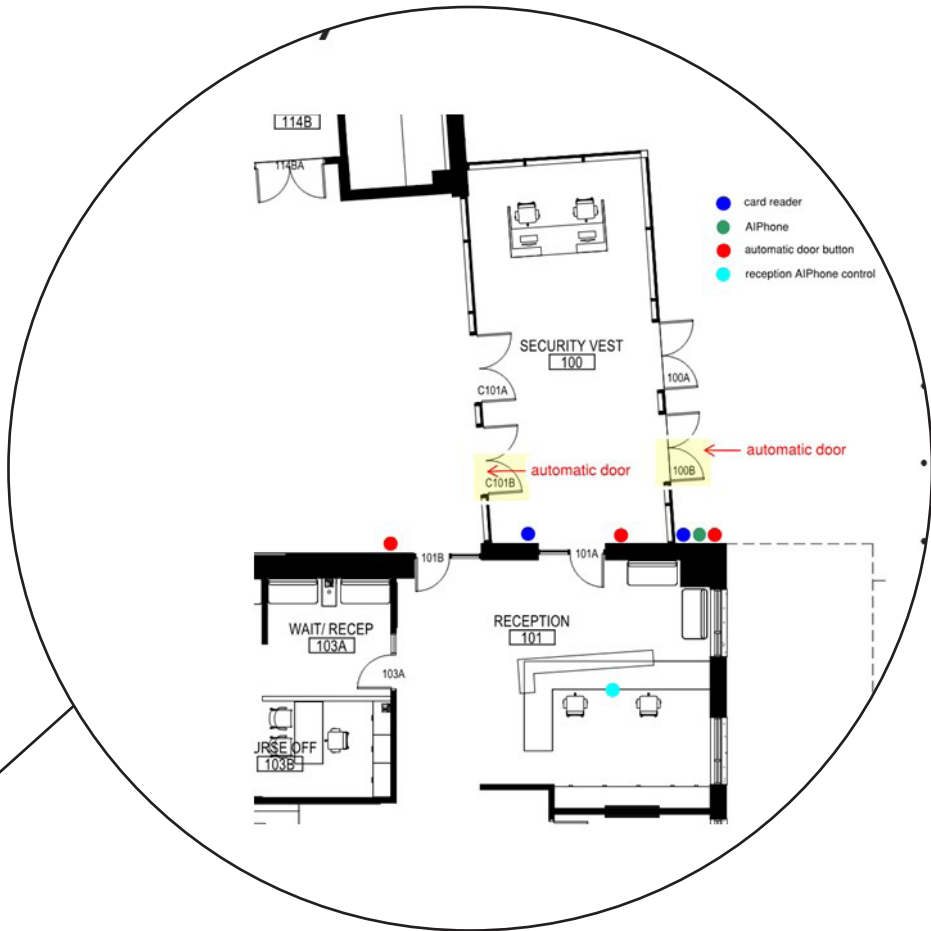
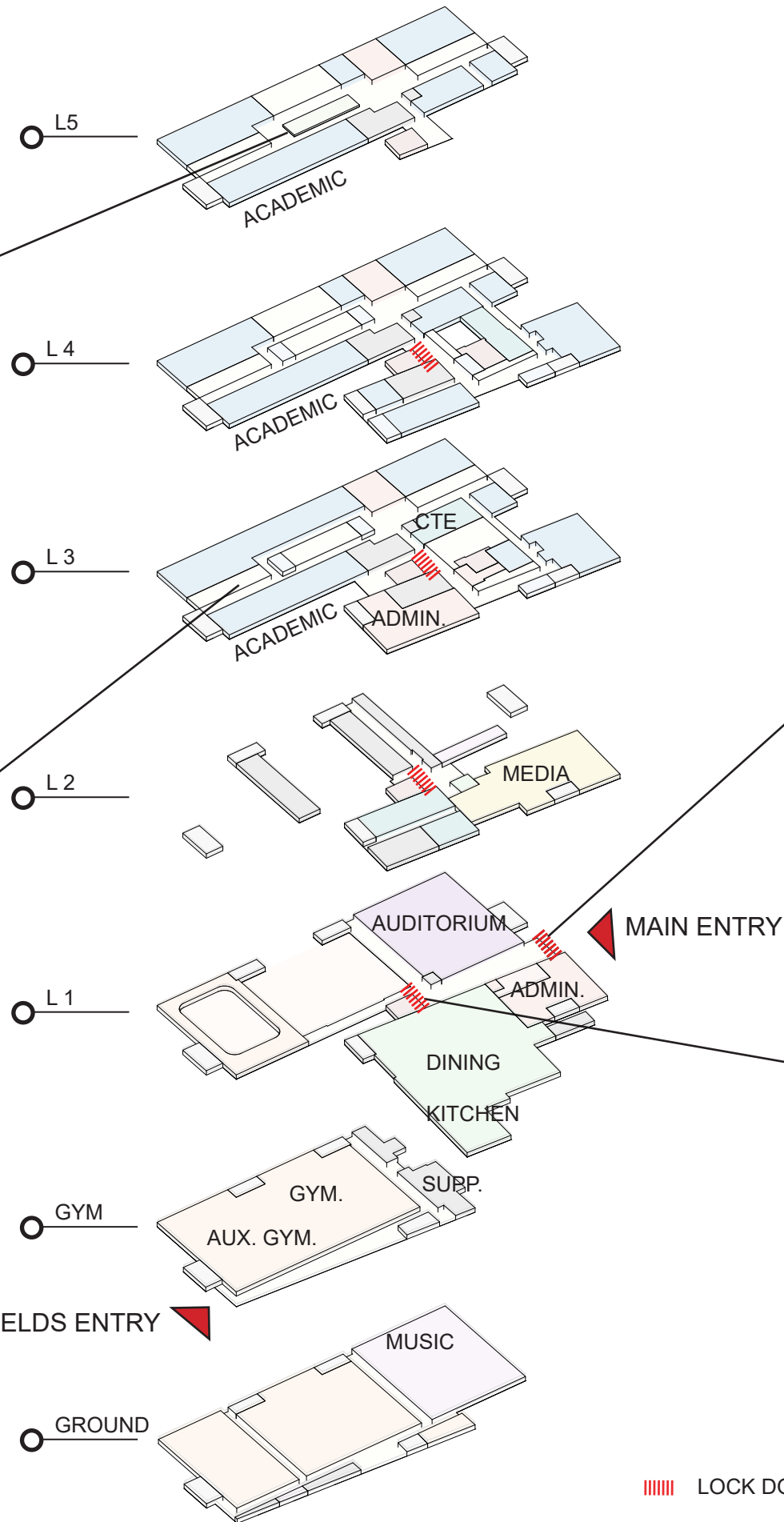

FCCPS MERIDIAN HIGH SCHOOL



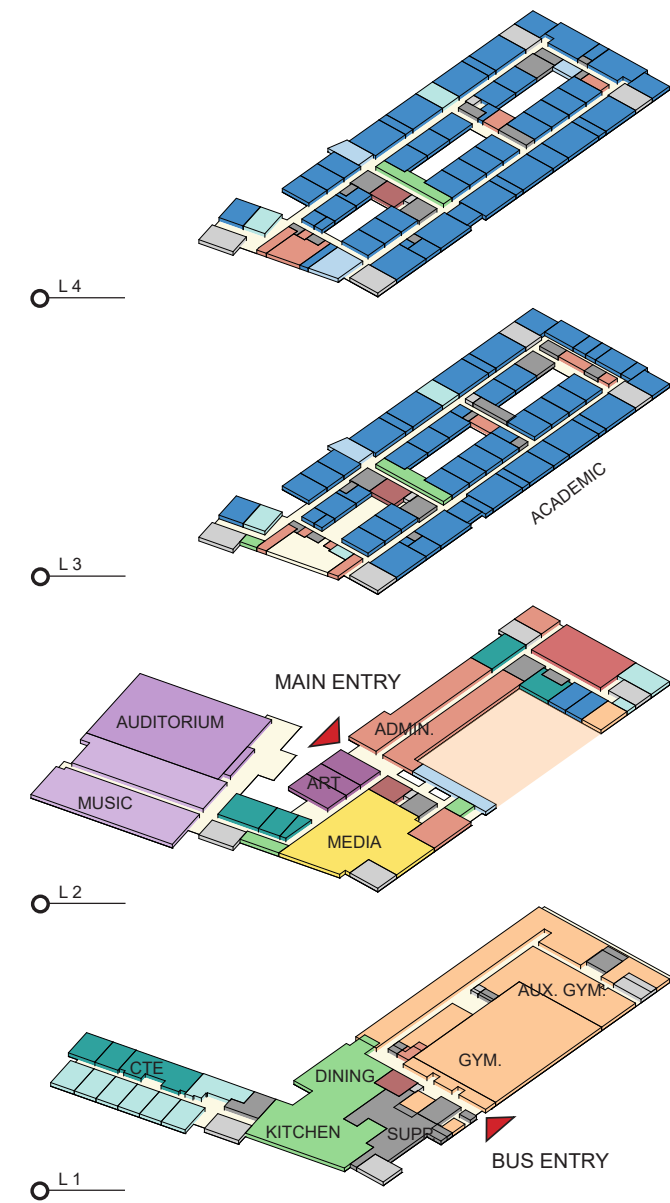
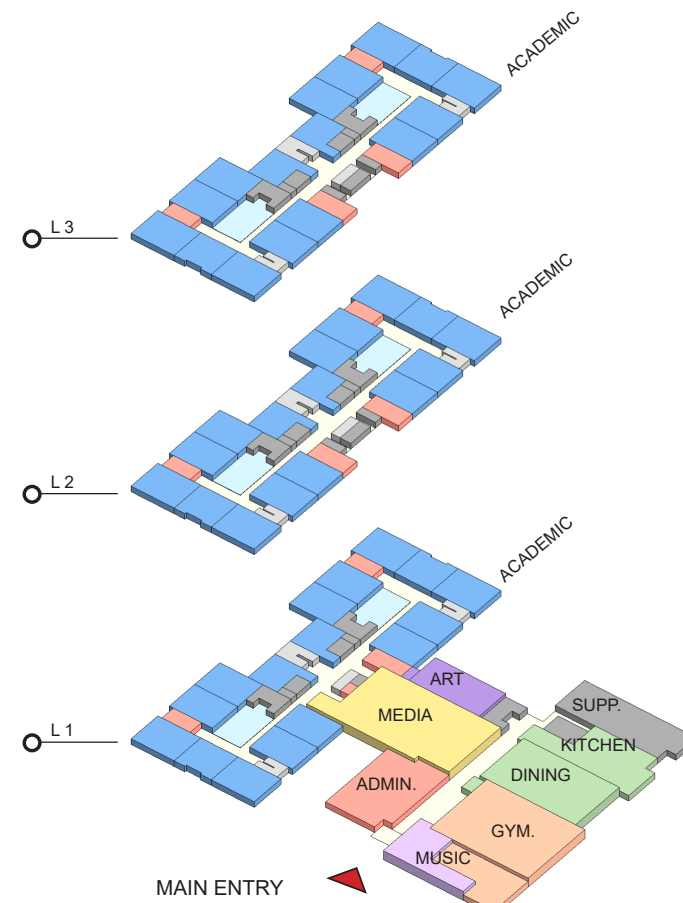
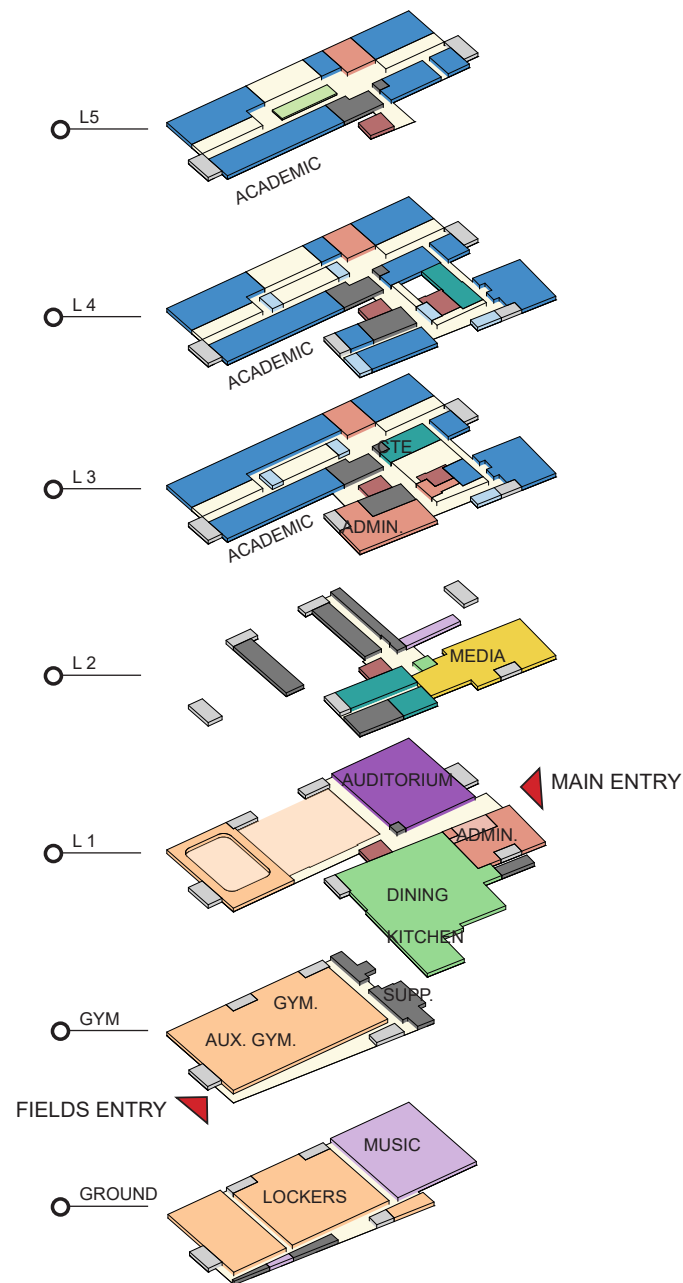
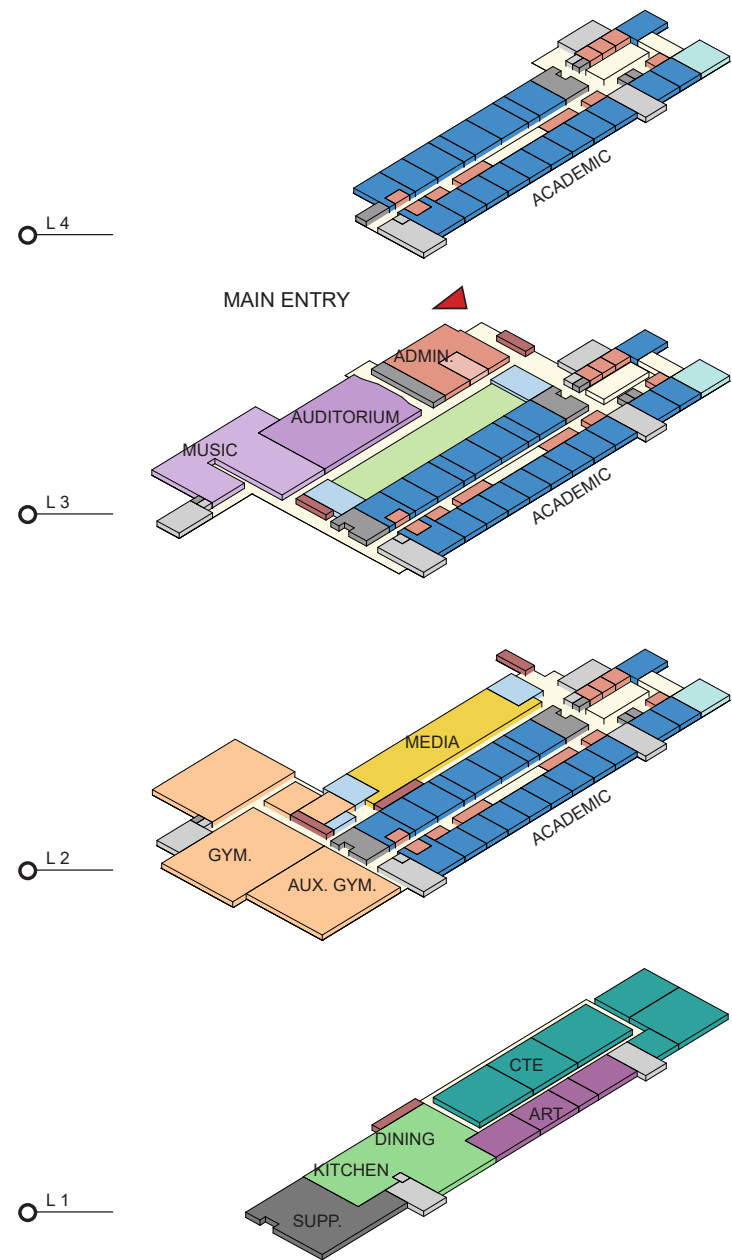



# QUESTIONS?

**VERTICAL SCHOOLS TURNING CHALLENGES INTO OPPORTUNITIES**

